

*Excellence For Health*



**Medical Consumables**



[www.medicaltd-china.com](http://www.medicaltd-china.com)



Yiwu Medica Import and Export Co., LTD  
Add: Office #812, 8th Floor, Jiaheng Apartment, 1543 Chouzhou North Road, Futian Street,  
Yiwu City, Jinhua City, Zhejiang Province, China  
Tell/WhatsApp: +8615216877512  
Email: [info@medicaltd-china.com](mailto:info@medicaltd-china.com)  
Web: [www.medicaltd-china.com](http://www.medicaltd-china.com)

CE Approved

# CONTENTS

Respiratory & Anesthesiology .....	01-12
Urine Bag .....	13-20
Medical tube & Catheters.....	21-36
Hypodermic & Accessories.....	37-48
Gloves.....	49-50
Blade & Lancets .....	51-53
Surgical Sutures & Needles.....	54-55
Gauze & Non-woven.....	56-61
Wound Dressing .....	62-74
Dental .....	75-77
Basic Dressing Set.....	78-78
First Aid .....	79-81
Hospital Uniform.....	82-90
Homecare .....	91-96
Sharp Container & Specimen Bag.....	97-100
Rapid Testing Series & Urinalysis Strips.....	101-102
Gynaecology.....	103-109
ECG Monitor System.....	110-112
Sterile Pouch & Autoclave Indicator Tape.....	113-114

[www.medicaltd-china.com](http://www.medicaltd-china.com)



Yiwu Medica Import and Export Co., LTD

Add:Office #812, 8th Floor, Jiaheng Apartment, 1543 Chouzhou North Road, Futian Street,

Yiwu City, Jinhua City, Zhejiang Province, China

Tell/WhatsApp: +8615216877512

Email: [info@medicaltd-china.com](mailto:info@medicaltd-china.com)

Web: [www.medicaltd-china.com](http://www.medicaltd-china.com)

CE Approved

# MEDICAL TUBES

[www.medicaltd-china.com](http://www.medicaltd-china.com)



**MEDICA**

Yiwu Medica Import and Export Co., LTD  
Add: Office #812, 8th Floor, Jiaheng Apartment, 1543 Chouzhou North Road, Futian Street,  
Yiwu City, Jinhua City, Zhejiang Province, China  
Tell/WhatsApp: +8615216877512  
Email: [info@medicaltd-china.com](mailto:info@medicaltd-china.com)  
Web: [www.medicaltd-china.com](http://www.medicaltd-china.com)



### GT010-110 Simple Oxygen Mask

Made of clear, medical grade PVC  
With adjustable nose clip  
With Anti-crush tube  
With elastic strap  
With 2.1m oxygen tube  
Latex free is available  
DEHP Free is available  
Size:XS,S,ML,XL  
Packing:PE bag



### GT010-150 Venturi mask

Made of clear, medical grade PVC  
With adjustable nose clip  
With Anti-crush tube  
With elastic strap  
With 2.1m oxygen tube  
7 density can be adjusted by two diluters  
Green:24%,26%,28%,30%;white:35%,40%,50%  
Latex free is available  
DEHP Free is available  
Size:S,M,L,XL  
Packing:PE bag



### GT010-170 Adjustable Venturi Mask

Made of clear ,medical grade PVC  
Adjustable nose clip  
6 diluters choice,each diluter for one oxygen density  
Oxygen concentration is blue 24%,  
Adaptor for high humidity  
Anti-crush tube  
With 2.1m oxygen tube  
Latex free is available  
DEHP Free is available  
Size :S,M,L,XL  
Packing:PE Bag



### GT012-100 Nebulizer Mask

Made of clear, medical grade PVC  
With adjustable nose clip  
With 2.1m oxygen tube  
Standard connceor  
Nebulizer jar volume:6cc,15cc  
Latex free is available  
DEHP Free is available  
Size:XS/S/M/L/XL  
Packing:PE Bag

### GT012-101 Elephant Nebulizer Mask

Made of clear, medical grade PVC

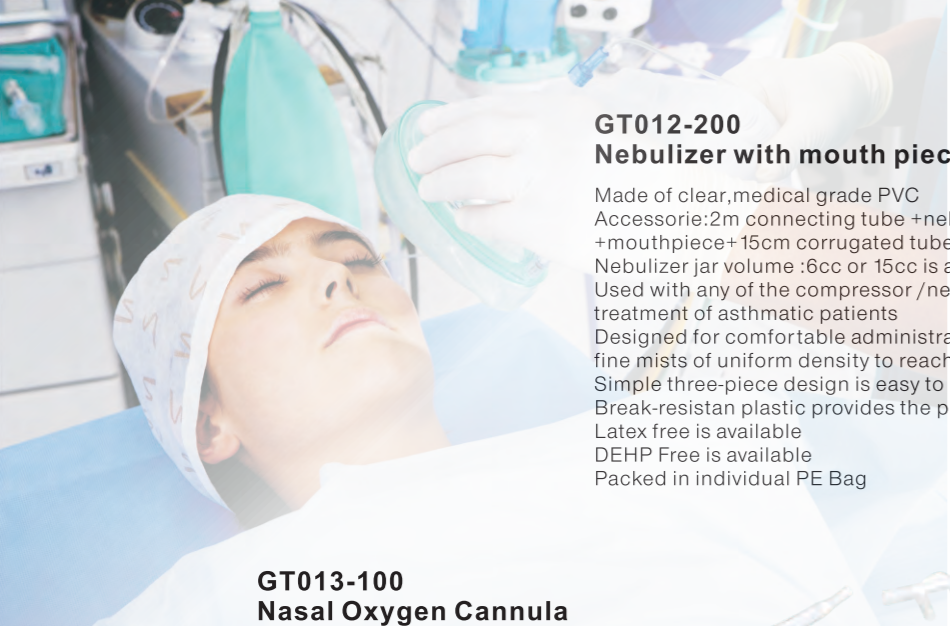

**GT012-200  
Nebulizer with mouth piece**

Made of clear,medical grade PVC  
 Accessorie:2m connecting tube +nebulizer jar  
 +mouthpiece+15cm corrugated tube  
 Nebulizer jar volume :6cc or 15cc is available  
 Used with any of the compressor /nebulizer for  
 treatment of asthmatic patients  
 Designed for comfortable administration of  
 fine mists of uniform density to reach deep into lung cavity  
 Simple three-piece design is easy to assemble and clean  
 Break-resistan plastic provides the patient with 14days of use with 15cm corrugated tube  
 Latex free is available  
 DEHP Free is available  
 Packed in individual PE Bag



**GT013-100  
Nasal Oxygen Cannula**

Made of clear ,medical grade PVC  
 Soft tip ,standard tip ,flared tip is available  
 with 2.1m/1.5m oxygen tube to be selected  
 Green/clear to be selected  
 Anti-crush tube  
 Latex free is available  
 DEHP Free is available  
 Size :Adult,Child ,Infant,Neonate  
 Packing:PE Bag



**Univeral connector**

Used for direct connection oxygen tanks or other machines

**GT010-120  
Tracheostomy Mask**

Made of clear ,medical grade PVC  
 Flexible plastic mask with elastic head strap  
 With 360 angle rotation connector Excellent compatible with  
 corrugated tubing &other connection device  
 Latex free is available  
 DEHP Free is available  
 Size:Adult and children  
 Packing:PE Bag



1L      750ML      500ML

**GT010-160 Oxygen Mask with Reservoir bag**

Made of clear ,medical grade PVC  
 Reservoir bag with/without check value  
 With adjustable nose clip  
 With Anti-crush tube  
 With elastic strap  
 With 2m/2.1m oxygen tube  
 Non-rebreathing mask provide a high  
 concentration of oxygen

Vol:500ML、750ML、1000ML  
 Latex free is available  
 DEHP Free is available  
 Size:Adult and children  
 Packed:PE Bag



**GT012-300C Disposable PVC Manual Resuscitator**

Color: Blue  
 Single patient use only  
 Built-in 60/40cm H2O pressure relief valve  
 The set includes oxygen reservoir bag, PVC mask and oxygen tubing  
 100% Medical level PVC material  
 Latex-free components  
 Additional Accessories (Airway, mouth opener) and customized label are available  
 Built-in 30mm exhale port for PEEP, Inlet Valve, or Manometer (Optional)  
 Size::Adult / Pediatric / Infant  
 Packing: PP Box / PE Bag / Paper Box



**GT012-300B Disposable SEBS Manual Resuscitator**

Color: Green  
 Single patient use only  
 Built-in 60/40cm H2O pressure relief valve  
 The set includes oxygen reservoir bag, PVC mask and oxygen tubing  
 100% Medical level PVC material  
 Latex-free components  
 Additional Accessories (Airway, mouth opener) and customized label are available  
 Built-in 30mm exhale port for PEEP, Inlet Valve, or Manometer (Optional)  
 Size:Adult / Pediatric / Infant  
 Packing: PP Box / PE Bag / Paper Box



**GT012-300A Disposable Silicone Manual Resuscitator**

Color : Natural  
 Autoclave to 134°C helping to prevent cross infection and contamination .  
 Built-in 60cm H2O pressure relief valve.  
 Latex-free high grade medical silicone material.  
 Guaranteed for 5 years or alternatively 20 times autoclave cycles.  
 All-in-one intake valve connects to oxygen reservoir bag directly.  
 Additional accessories (Airway, mouth opener )and customized label are available.  
 Built-in 30mm exhale port for PEEP, Inlet Valve, or Manometer (Optional).  
 Size:Adult / Pediatric / Infant  
 Packing:PP Box / PE Bag / Paper Box



**GT013-101 O2+CO2 Nasal Cannulas**

CO2/O2 nasal cannulas for monitoring expired gases from one nare while  
 delivery O2 through the other.  
 Standard tip or soft tip is available  
 Latex free is available  
 DEHP Free is available  
 Size:Adult,Child ,Infant,Neonate  
 Packing :PE Bag



**GT012-400S Silicone Anesthesia Mask**

Transparent for visual check of bleeding, vomitus, and spontaneous breathing  
Available in one piece or dome/cuff type  
Cover the 9 sizes from preterm baby to Adult-XL  
All models are reusable and can be autoclaved repeatedly at 134OC  
Latex-free

Size	Port	QTY/CTN	Carton Size	Description
000#	15OD	300	46x36x30cm	Premature
00#	15OD	300	46x36x30cm	Premature
0#	15OD	200	46x36x30cm	Neonate
1#	15OD	200	46x36x30cm	Infant
2#	22ID	100	46x36x30cm	Pediatric
3#	22ID	100	46x36x30cm	Adult-S
4#	22ID	100	57x33.5x39cm	Adult-M
5#	22ID	100	57x33.5x39cm	Adult-L
6#	22ID	80	57x33.5x46cm	Adult-XL

**Round Mask**

Size	000#	00#	0#	1#	2#
Port	15OD	15OD	15OD	15OD	22ID
Description	Premature	Premature	Neonate	Infant	Pediatric

**GT012-400 PVC Anesthesia Mask**

Transparent for visual check of bleeding, vomitus, and spontaneous breathing  
Available in one piece or dome/cuff type  
Cover the 9 sizes from preterm baby to Adult-XL  
All models are reusable and can be autoclaved repeatedly at 134 °C  
Latex-free



400PB

**Soft Cushion Anesthesia Mask**

Size	Hook Color	Port	Description
0#	White	15OD	Premature
1#	Pink	15OD	Neonate
2#	Yellow	15OD	Infant
3#	Green	22ID	Pediatric
4#	Red	22ID	Adult-S
5#	Blue	22ID	Adult-M
6#	Orange	22ID	Adult-L

**PVC Anesthesia Mask**

Size	Hook Color	Port	Description
0#	White	15OD	Neonate
1#	Pink	15OD	Infant
2#	Yellow	22ID	Pediatric
3#	Green	22ID	Adult-S
4#	Red	22ID	Adult-M
5#	Blue	22ID	Adult-L
6#	Orange	22ID	Adult-L

**PVC Free-Anesthesia Mask**

Size	Cushion Color	Port	Description
1#	Blue	15OD	Neonate
2#	Orange	15OD	Infant
3#	Pink	22ID	Pediatric
4#	White	22ID	Adult-S
5#	Yellow	22ID	Adult-M
6#	Green	22ID	Adult-L

400PC



**GT117-300 CPR Mask**

CPR Mask is especially designed to be used for First-Aid rescuing and training. The mask features a replaceable one-way valve with biological filter in one housing  
Features:  
This mask is made of environmental material  
With one-way valve to avoid any direct contact between overcome hesitation to start resuscitation  
Apply to Resuscitation, First aid training, Hospital, School or being used as accessory of first aid kit  
Box Color: Red, Blue, Green, White.  
Packing: PP Box / Mini PP Box / PE Bag

**GT117-400 Simple CPAP Mask**

CPAP Mask is an interface for the treatment of obstructive sleep apnea using continuous positive airway pressure. It provide a good seal when fitted to the patient whilst providing maximum comfort.  
Size: Adult-S, Adult-M, Adult-L  
Accessories: PEEP Valve, Headgear(Adult, Pediatric).



2# 1# 0#  
00# 000#



400PA

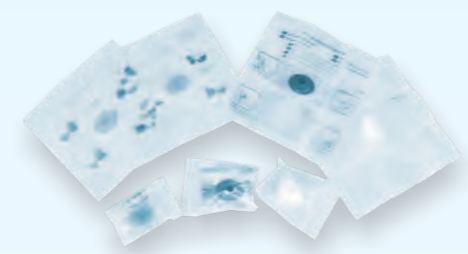

**GT117-100**

**Breathing Mask With One-way Valve**

Made of PE & PP (Mask is PE and Valve PP), environmental material, crystal. With one-way valve to avoid any direct contact between patient and rescuer on mouth, nose and face. And help overcome hesitation to start resuscitation. Apply to Resuscitation, First aid training, Hospital, School or being used as accessory of First aid kit.  
Packing: PE Bag



**GT117-200**

**Filter-CPR-face-shield**

1000pcs/ctn, 36x33x25cm;  
1pc/bag, 1000bags/ctn, 36x36x23cm



**GT016-500P**

Mask material: silicone or PVC

**GT016-500**

**Mask Nebular Container**

It is an auxiliary tool of MDI inhalation treatment, and it is used to store aerosol. It is mainly used among children and patients with poor coordination of inhalation and hand gestures, or obvious side effect in throat after using aerosol. Especially, spacer can significantly reduce side effect of cortical hormone inhalation.  
Size: 160ml S/M/L  
Packing: PP Bag



Model:A

Model:B

**GT016-300**

**Peak flow meter**

It is an instrument used to measure asthma patients' PEPR (peak exhalation flow rate). It is an ideal tool for objective monitoring of asthma patients, and it can help patients find out signs of exacerbation as early as possible.  
Size: Child / Adult  
Packing: PP Bag



Model:A

Model:B

**GT016-400**

**Three Balls Spirometer**

Function: The patients received abdominal or chest surgery is used to help improve the respiratory depth and duration of.  
Package: PP plastic bags by single set, with an enclosed English specification.  
50pcs are packaged in a carton. Packed after seal, and adopt ethylene oxide for sterilization.  
Size: Three color balls / Single color balls  
Packing: PP Bag



GT016-500ML

GT016-250ML

GT016-100ML

**Humidifier**

Function: A bottle used to turn liquid or a liquid medication into smaller particles to be delivered to a patient's nose, throat or lungs via the nose, mouth or a breathing.  
Ethylene oxide for sterilization. as possible.  
Size: 500ml, 250ml, 100ml  
Packing: PP Bag

**GT032-300  
Disposable Heat Moisture  
Exchange Filter(HME Filter)**

Function:moistening,warming and filtering the gas that come out from the breathing machine.  
Made by medical plastic PP.  
High effective filtering rate : 99.99%  
Size:Adult, Child  
Packing:Individual Blister Bag

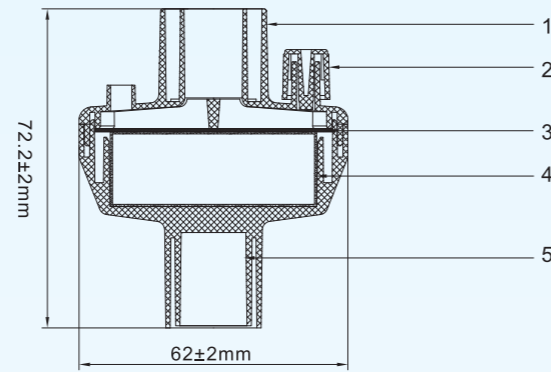

NO.	Components	Material	Quantity
1	Upper Cover	PVC	1
2	Screw Cap	PP	1
3	Filteringmembrane	polyurethane	1
4	Humidifying paper	/	1
5	Lower Cover	PP	1



**Catheter Mount**

Length:18CM  
Size:15mm,22mm  
Packing :Individual Blister Bag

**GT032-400A  
Disposable Tracheostomy  
Heat Moisture Exchanger**

Tidal Volume:200-1500ml;Moisture Output(mg H2O / L air):24/25mg@Vt 500ml;Resistance(cm H2O) :<2.3@60L/min  
size:Adult  
Packing:Individual Blister Bag

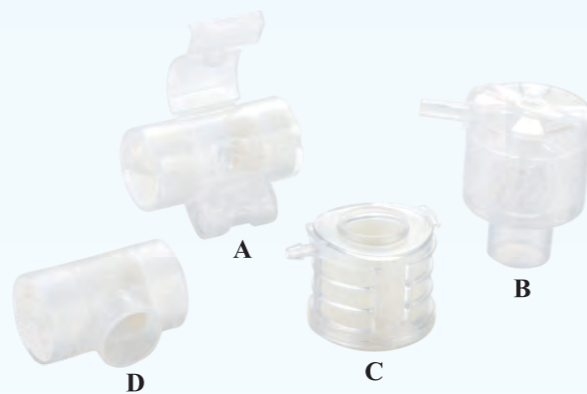

Model	GT032-400A	GT032-400B	GT032-400C	GT032-400D
Recommended tidal volum(ml)	>75	>75	>75	>75
Moisture loss * (mg H2O/lair)	9.0(@Vt 500ml)	9.2(@Vt 500ml)	9.0(@Vt 500ml)	9.0(@Vt 500ml)
Resistance(pa)	15 at 30l/min	50 at 30l/min	20 at 30l/min	20 at 30l/min

**GT032-200  
Disposable Bacterial/Viral Filter**

Function:Mainly used for filtering the bacterial,viral and wetting the gases in breathing machine and anesthesia circuits, also can be used with Lung function examination equipment to protect the instruments by filtering the bacterial.  
Made of medical high polymer material.  
Filter medium is primarily a superfine polypropylene fiber with static electricity,and polypropylene is Hydrophobic materials that restrains the growing of fungus,bacterial and viral.  
Packing:Individual Blister Bag



NO.	Components	Material	Quantity
1	Upper Cover	PVC	1
2	Screw Cap	PP	1
3	Filteringmembrane	polyurethane	1
4	Lower Cover	PP	1

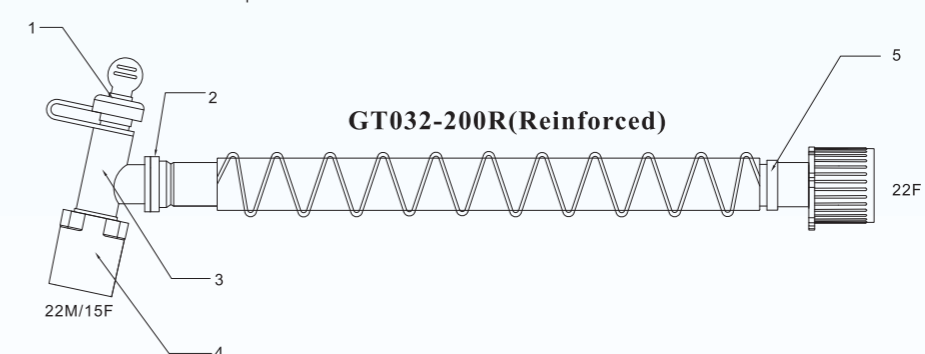
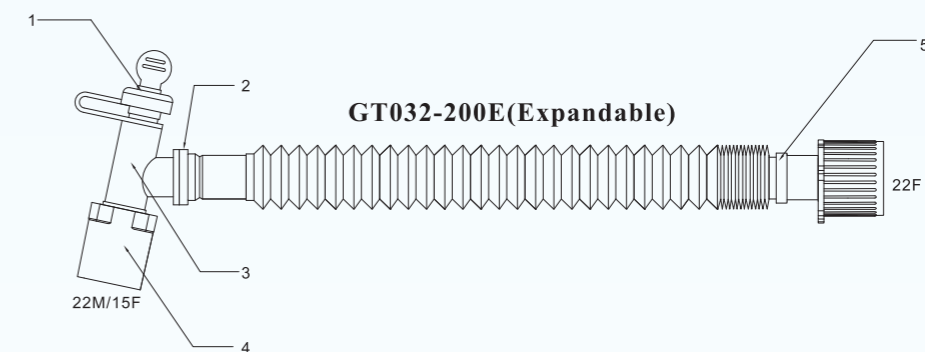
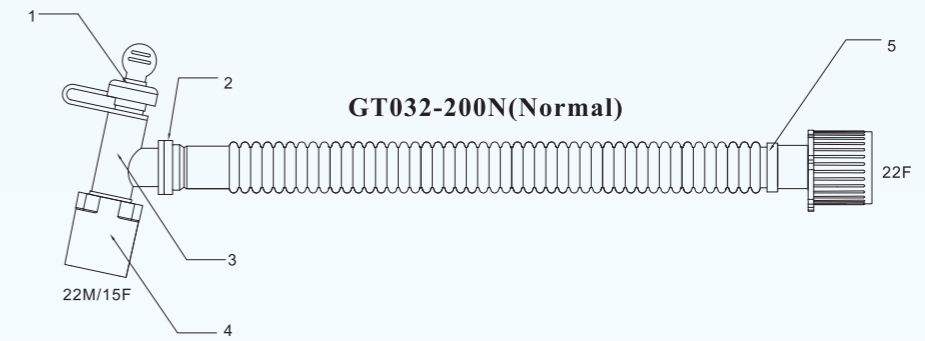
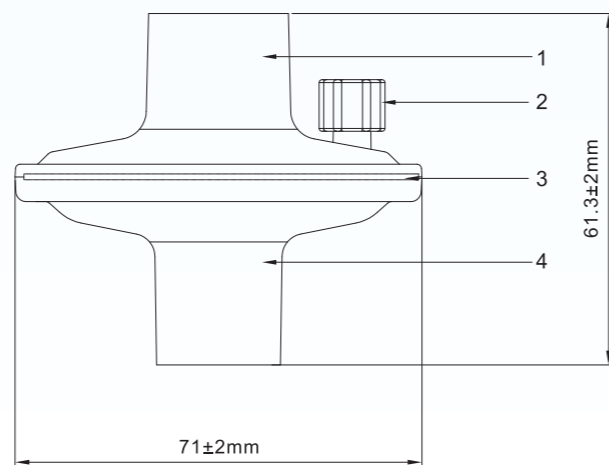

NO.	Components	Material	Quantity
1	Stifle Cover	PVC	1
2	Side connector	PP	1
3	3-way connector	PP	1
4	Straight connector	PP	1
5	Tube connector	PP	1

# Anesthesia Breathing Circuit

Types: Reinforced PVC, Normal, Expandable  
 Length: 1.2m/1.6m/1.8m, length can be customized  
 Standard connectors: 15mm, 22mm  
 To match with anesthesia machine or breathing machine, as a use of piping anesthetic gases, oxygen and other medical gases into patient.  
 Made by non-toxic and smell-less material PP and PE, with the characteristics of good elasticity, flexibility and pressure tightness.  
 Size available: Adult, Child  
 Packing : Individual Blister Bag

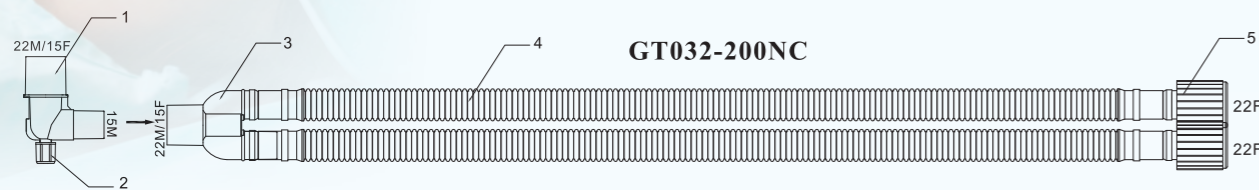

GT032-200NC

## Normal Anesthesia Circuit-Child

NO.	Components	Material	Quantity
1	90°elbow	PP	1
2	Screw Cap	PP	1
3	3-way connector	PP	1
4	Corrugated pipe	PE	2
5	Tube connector	PP	2

Type/Size	Length
corrugated tube for Child 1.0m	1.0m
corrugated tube for Child 1.2m	1.2m
corrugated tube for Child 1.5m	1.5m
corrugated tube for Child 1.8m	1.8m

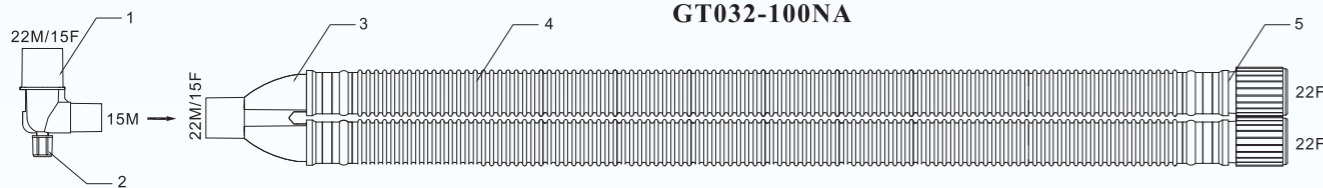

GT032-100NA

## Normal Anesthesia Circuit-Adult

NO.	Components	Material	Quantity
1	90°elbow	PP	1
2	Screw Cap	PP	1
3	3-way connector	PP	1
4	Corrugated pipe	PE	2
5	Tube connector	PP	2

Type/Size	Length
Corrugated tube for Adult 1.0m	1.0m
Corrugated tube for Adult 1.2m	1.2m
Corrugated tube for Adult 1.5m	1.5m
Corrugated tube for Adult 1.8m	1.8m

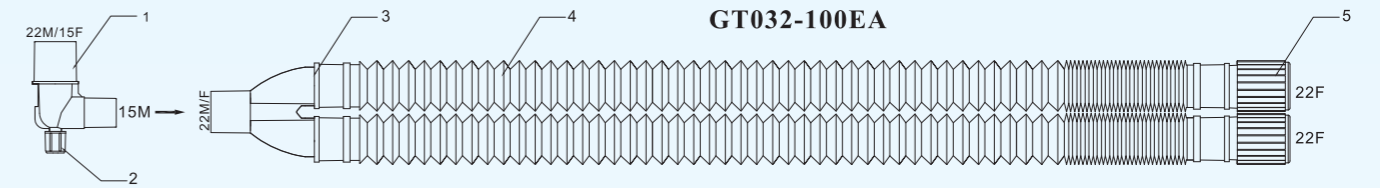

GT032-100EA

## Expandable Anesthesia Circuit-Adult

NO.	Components	Material	Quantity
1	90°elbow	PP	1
2	Screw Cap	PP	1
3	3-way connector	PP	1
4	Expandable pipe	PP	2
5	Tube connector	PP	2

Type/Size	Length
Expandable tube for Adult 1.0m	1.0m
Expandable tube for Adult 1.2m	1.2m
Expandable tube for Adult 1.5m	1.5m
Expandable tube for Adult 1.8m	1.8m

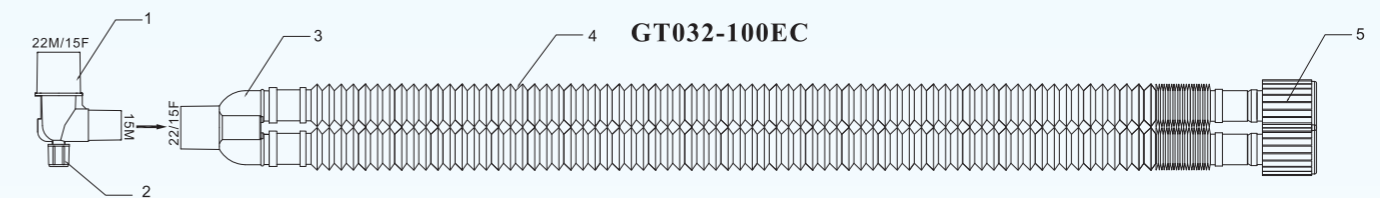

GT032-100EC

## Expandable Anesthesia Circuit-Child

NO.	Components	Material	Quantity
1	90°elbow	PP	1
2	Screw Cap	PP	1
3	3-way connector	PP	1
4	Expandable tube	PP	2
5	Tube connector	PP	2

Type/Size	Length
Expandable tube for Child 1.0m	1.0m
Expandable tube for Child 1.2m	1.2m
Expandable tube for Child 1.5m	1.5m
Expandable tube for Child 1.8m	1.8m

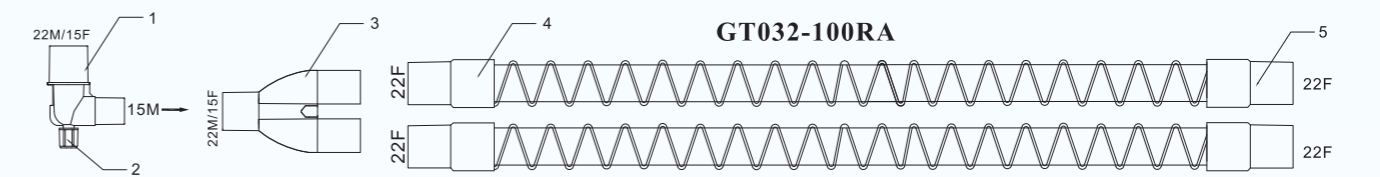

GT032-100RA

## Reinforced Anesthesia Circuit-Adult

NO.	Components	Material	Quantity
1	90°elbow	PP	1
2	Screw Cap	PP	1
3	3-way connector	PP	1
4	Reinforced Tube	PVC	2
5	Tube connector	PVC	4

Type/Size	Length
Reinforced tube for Adult 1.5m	1.5m
Reinforced tube for Adult 1.8m	1.8m

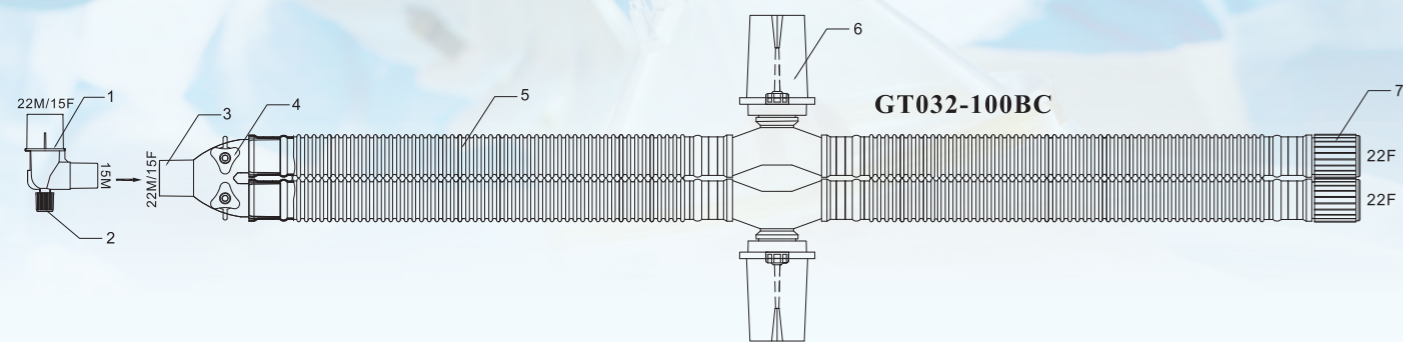
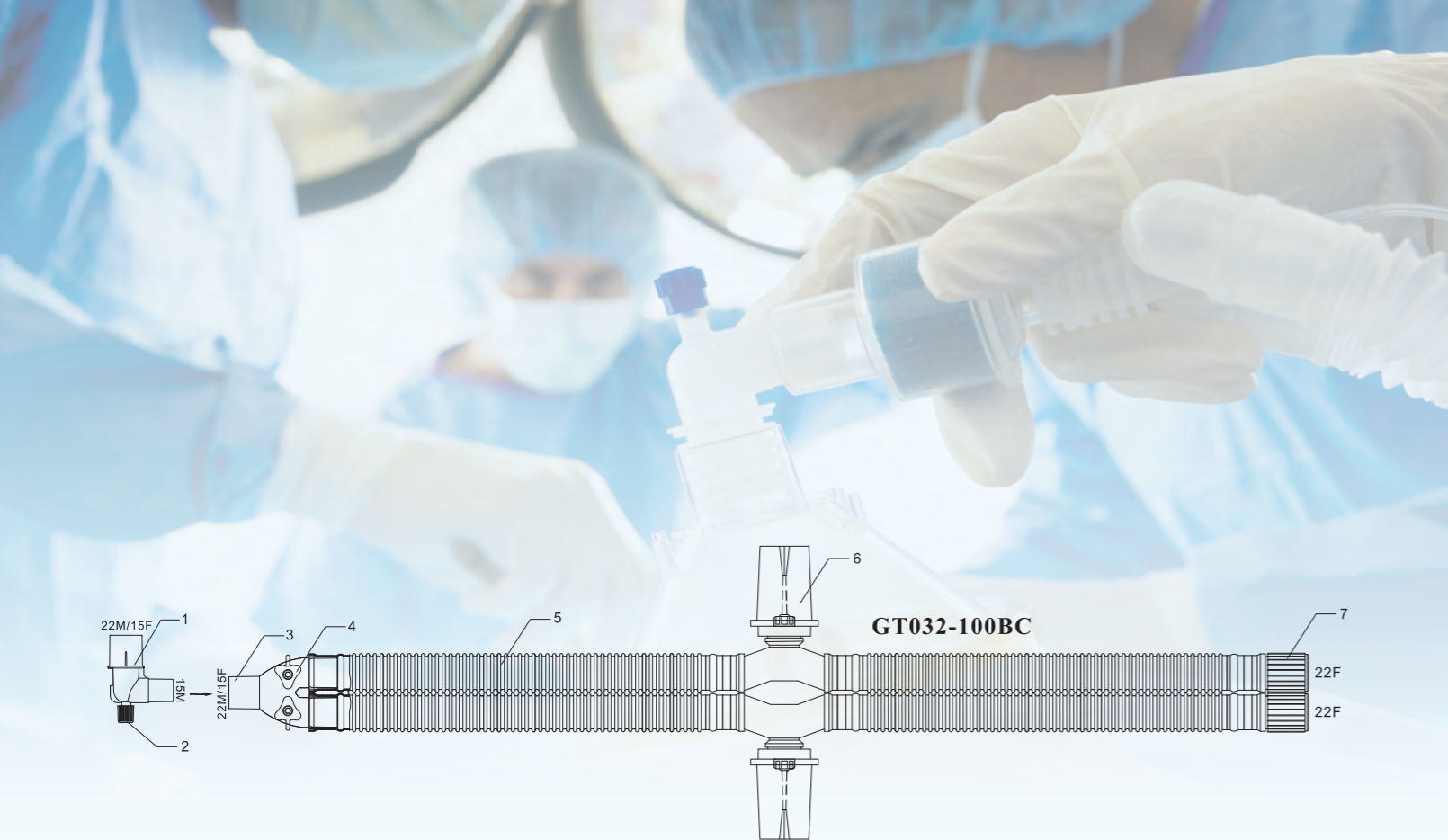

**Expandable Breathing Circuit with Watertrap**

NO.	Components	Material	Quantity
1	90°elbow	PP	1
2	Screw Cap	PP	1
3	3-way connector	PP	1
4	Stifle Cover	PVC	2
5	Corrugated pipe	PE	4
6	Water trap	PP	2
7	Tube connector	PP	2

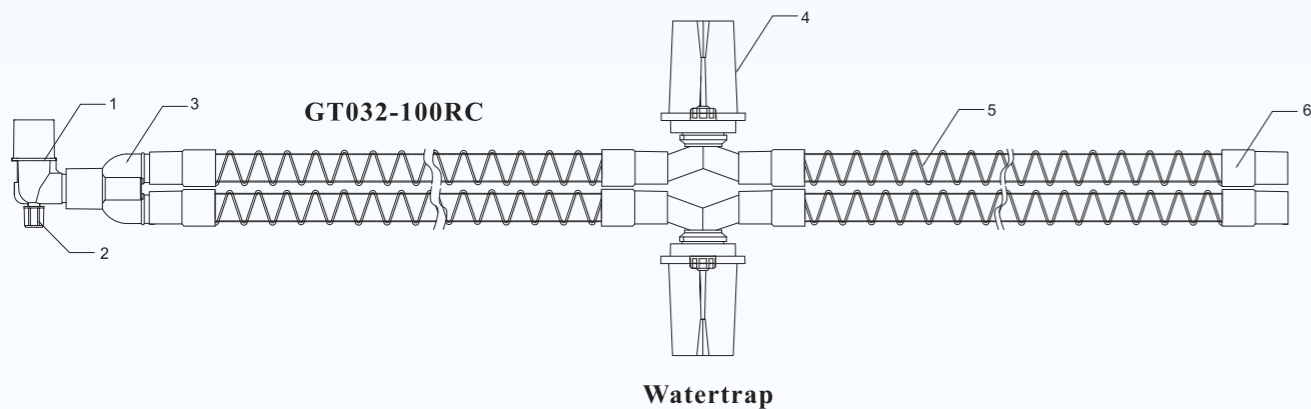

**Watertrap**

**Reinforced Anesthesia Circuit-Child**

NO.	Components	Material	Quantity
1	90°elbow	PP	1
2	Screw Cap	PP	1
3	3-way connector	PP	1
4	Reinforced tube	PVC	2
5	Tube connector	PVC	2

Type/Size	Length
Reinforced tube for Child 1.0m	1.0m
Reinforced tube for Child 1.2m	1.2m
Reinforced tube for Child 1.5m	1.5m
Reinforced tube for Child 1.8m	1.8m

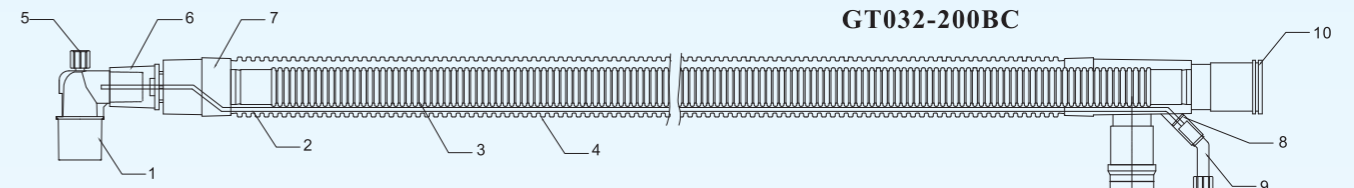

**Coaxial Breathing Circuit**

NO.	Components	Material	Quantity
1	90°elbow	PP	1
2	Coaxial small thin tube	PVC	1
3	Coaxial inner tube	PE	1
4	Coaxial outer tube	PP	1
5	Screw Cap	PP	2
6	Rotation connector	PP	1
7	Straight Connector	PP	1
8	Gasket	Medical Silicone	1
9	Small elbow connector	PVC	1
10	3-way connector	PP	1
11	Corrugated tube	PE	1
12	Tube Connector	PP	1

Type/Size	Length
Coaxial Breathing Circuit 1.5m	1.5m
Coaxial Breathing Circuit 1.8m	1.8m
Coaxial Breathing Circuit 2.1m	2.1m
Coaxial Breathing Circuit 2.4m	2.4m



**GT032-100LB Breathing bag(Latex-Latex/free)**

Size & Specification :  
 0.5L, Latex  
 1L, Latex  
 2L, Latex  
 3L, Latex  
 0.5L, Latex-free  
 1L, Latex-free  
 2L, Latex-free  
 3L, Latex-free

**GT029-1600S Chest Drainage Bottle**

Single Chamber  
 Size:1600ml  
 Packing :Blister Bag / PE Bag

**GT029-2000D Chest Drainage Bottle**

Two Chambers  
 Size:2000ml  
 Packing :Blister Bag / PE Bag





**GT028-100**  
**Economic Urinary Drainage Bag**

Capacity: 2000ml  
Without bottom outlet; with 90cm inlet tube,  
with non-return valve,  
Sterilization: EO  
Packing: 1pc/PE bag, 250pcs/carton  
Measurement of carton: 52x32x36cm



**GT028-200**  
**Economic Urinary Drainage Bag**

Capacity: 2000ml  
with bottom outlet; with 90cm inlet tube;  
with non-return valve  
with pull-push valve  
Sterilization: EO  
Form of packing: 1pc/PE bag, 250pcs/carton  
Measurement of carton: 540x400x270mm



**GT028-310**  
**Luxury Urinary Drainage Bag**

Capacity: 2000ml  
Type: Square bottom; Latex free  
with twist valve; with white sample port;  
with anti-reflux valve ; with plastic tie  
Inlet tube: O.D 10mm; 100cm length  
Sterilization: EO  
Form of packing: 1pc/Blister pack, 100pcs/carton  
Measurement of carton: 540x360x320mm



**GT028-320**  
**Luxury Urinary Drainage Bag**

Capacity: 2000ml  
Type: Square bottom; Latex free  
with T valve; with white sample port;  
with anti-reflux valve ; without plastic tie  
Inlet tube: O.D 10mm; 100cm length  
Sterilization: EO  
Form of packing: 1pc/Blister pack, 100pcs/carton  
Measurement of carton: 540x360x320mm



**GT028-210**  
**Economic Urinary Drainage Bag**

Capacity: 2000ml  
With bottom outlet; with 90cm inlet tube;  
with non-return valve, with T valve  
Sterilization: EO  
Packing: 1pc/PE bag, 250pcs/carton  
Measurement of carton: 52x37x32cm



**GT028-300**  
**Luxury Urinary Drainage Bag**

Capacity: 2000ml  
Type: square bottom, latex free, with pull push valve,  
with white sample port, with anti-reflux valve, with plastic tie  
Inlet tube: O.D 10mm; 100cm length  
Sterilization: EO  
Packing: 1pc/ PE or blister pack, 100pcs/carton,  
Measurement of carton: 54x36x32cm



**GT028-330**  
**Luxury Urinary Drainage Bag**

Capacity: 2000ml  
Type: Square bottom; Latex free  
with T valve; with white sample port; with anti-reflux valve  
with plastic tie  
Inlet tube: O.D 10mm; 100cm length  
Sterilization: EO  
Form of packing: 1pc/Blister pack, 100pcs/carton  
Measurement of carton: 540x360x320mm



**GT028-340**  
**Luxury Urinary Drainage Bag**

Capacity: 2000ml  
Type: Square bottom; Latex free  
with T valve; without sample port; with anti-reflux valve  
with double ropes  
Thickness film: 0.11 mm per ply, Front film is transparent  
Back film is white  
Inlet tube: O.D 6.5mm; 90cm length  
Sterilization: EO  
Form of packing: 1pc/Blister pack, 100pcs/carton  
Measurement of carton: 540x360x320mm



**GT028-400  
Luxury Urinary Drainage Bag**

Capacity: 2000ml  
 Type: Square bottom; Latex free with side valve; with anti-reflux valve with single plastic hanger and tubing clip  
 Inlet tube: O.D 10mm; 110cm length  
 Sterilization: EO  
 Form of packing: 1pc/Blister pack, 40pcs/carton  
 Measurement of carton: 430x320x380mm



**GT028-410  
Luxury Urinary Drainage Bag**

Capacity: 2000ml  
 Type: Square bottom; Latex free with Single reversal valve; with needle sample port with anti-reflux valve; with double plastic hanger and single rope with blue bed sheet clip  
 Inlet tube: O.D 10mm; 100cm length  
 Sterilization: EO  
 Form of packing: 1pc/Blister pack, 40pcs/carton  
 Measurement of carton: 430x320x380mm



**GT028-600  
Luxury Urinary Drainage Bag**

Capacity: 2000ml  
 Type: pyriform; latex free, with 100% silicone blue outlet and with folding clamp, with needle sample port, with anti-reflux valve, with finger guard clamp  
 Inlet tube: O.D10mm; 100cm length  
 Sterilization: EO  
 Form of packing: 1pc/PE or blister pack, 20pcs/carton.  
 Measurement of carton: 38x22x15cm



**GT028-700  
Urinary Drainage Bag**

Capacity: 2000ml  
 Type: Pyriform; Latex free with T valve; with needle sample port; with anti-reflux valve with double plastic hanger and rope; with white bed sheet clamp  
 Inlet tube: O.D 10mm; 110cm length  
 Sterilization: EO  
 Form of packing: 1pc/Blister pack, 40pcs/carton  
 Measurement of carton: 430x300x380mm



**GT028-500  
Luxury Urinary Drainage Bag**

Capacity: 2000ml  
 Type: Square bottom; Latex free with twist valve; with anti-reflux valve; with plastic tie  
 Front and back films are transparent  
 Inlet tube: O.D 6.5mm; 90cm length  
 Sterilization: EO  
 Form of packing: 1pc/Blister pack, 100pcs/carton  
 Measurement of carton: 450x360x330mm



**GT028-510  
Luxury Urinary Drainage Bag**

Capacity: 2000ml  
 Type: semicircular bottom, Latex free with twist valve; with anti-reflux valve; with plastic tie  
 Front and back films are transparent  
 Inlet tube: O.D 6.5mm; 90cm length  
 Sterilization: EO  
 Form of packing: 1pc/PE bag, 100pcs/carton  
 Measurement of carton: 440x360x240mm



**GT028-800  
Urinary Drainage Bag**

Capacity: 2000ml  
 Type: Pyriform; Latex free with T valve; with needle sample port; with anti-reflux valve with blue plastic hanger and rope; with white bed sheet clamp  
 Inlet tube: O.D 10mm; 100cm length  
 Sterilization: EO  
 Form of packing: 1pc/Blister pack, 20pcs/carton  
 Measurement of carton: 310x260x220mm



**GT028-810  
Urinary Drainage Bag**

Capacity: 2000ml  
 Type: Pyriform; Latex free with T valve; with needle sample port; with anti-reflux valve with white double plastic hanger and rope; with white bed sheet clamp  
 Inlet tube: O.D 10mm; 110cm length  
 Sterilization: EO  
 Form of packing: 1pc/Blister pack, 40pcs/carton  
 Measurement of carton: 430x300x380mm



**GT028-900  
Luxury Urinary Drainage Bag**

Capacity: 4000ml  
with T valve; Latex free;  
with anti-reflux drip chamber (one part)  
with needle sample port and tubing clip is optional  
with anti-reflux valve;  
with reinforced double plastic hanger and rope  
with blue bed sheet clamp  
Inlet tube: O.D 11mm; 110cm length  
Sterilization: EO  
Form of packing: 1pc/Blister pack, 40pcs/carton  
Measurement of carton: 430x300x380mm



**GT028-910  
Luxury Urinary Drainage Bag**

Capacity: Type A : 2000ml / Type B : 2500ml  
with T valve; Latex free;  
with anti-reflux drip chamber (one part)  
with needle Sample port and tubing clip is optional  
with anti-reflux valve;  
with reinforced double plastic hanger and rope  
with white bed sheet clamp  
Inlet tube: O.D 10mm; 110cm length  
Sterilization: EO  
Form of packing: 1pc/Blister pack, 40pcs/carton  
Measurement of carton: 430x300x380mm



**GT029-300  
Urine Meter Drainage Bag**

Capacity: 2600ml+400ml; Latex free  
with T valve on urine bag;  
with twist valve on urine meter  
with needle sample port; with anti-reflux valve  
with reinforced double plastic hanger and rope  
with white bed sheet clamp  
Inlet tube: O.D 11mm; 130cm length  
Sterilization: EO  
Form of packing: 1pc/Blister pack, 10pcs/carton  
Measurement of carton: 480x410x250mm



**GT029-310  
Urine Meter Drainage Bag**

Capacity: 2600ml+500ml, Latex free  
with T valve on urine bag ; with twist valve on urine meter  
with needle Sample port; with anti-reflux valve  
with reinforced double plastic hanger and rope  
with white bed sheet clamp  
Inlet tube: O.D 11mm; 130cm length  
Sterilization: EO  
Form of packing: 1pc/Blister pack, 10pcs/carton  
Measurement of carton: 480x410x250mm



**GT028-920  
Luxury Urinary Drainage Bag**

Capacity: 2000ml  
with T valve; Latex free;  
with anti-reflux drip chamber (Three part)  
with needle sample port and tubing clip is optional  
with anti-reflux valve;  
with reinforced double plastic hanger and rope  
with blue bed sheet clamp  
Inlet tube: O.D 11mm; 110cm length  
Sterilization: EO  
Form of packing: 1pc/Blister pack, 40pcs/carton  
Measurement of carton: 430x300x380mm



**GT029-100  
Luxury Urinary Drainage Bag**

Capacity: 2000ml  
with T valve; Latex free;  
with anti-reflux drip chamber (Three part)  
with needle sample port and tubing clip is optional  
with anti-reflux valve;  
with reinforced double plastic hanger and rope  
with blue bed sheet clamp  
Inlet tube: O.D 11mm; 110cm length  
Sterilization: EO  
Form of packing: 1pc/Blister pack, 40pcs/carton  
Measurement of carton: 430x300x380mm



**GT029-320  
Urine Meter Drainage Bag**

Capacity: 2000ml+200ml; Latex free  
with T valve on urine bag; with twist valve on urine meter  
with needle sample port; with anti-reflux valve  
with reinforced double plastic hanger and rope  
with white bed sheet clamp  
Inlet tube: O.D 11mm; 130cm length  
Sterilization: EO  
Form of packing: 1pc/Blister pack, 10pcs/carton  
Measurement of carton: 480x410x250mm



**GT029-330  
Urine Meter Drainage Bag (Double Chambers)**

Easy to read molded plastic meters are calibrated up to 400 ml urine meter  
with T valve on urine bag ; with twist valve on urine meter  
with needle sample port; with anti-reflux valve  
with reinforced double plastic hanger and rope  
with white bed sheet clamp  
Inlet tube: O.D 11mm; 130cm length  
Sterilization: EO  
Form of packing: 1pc/Blister pack, 10pcs/carton  
Measurement of carton: 480x410x250mm



**GT029-340  
Urine Meter Drainage Bag**

Easy to read molded plastic meters are calibrated up to 500 ml urine meter  
with 2000ml Luxury Urinary Drainage bag  
with anti-reflux drip chamber (one part)  
with T valve on urine bag; with needle sample port  
with anti-reflux valve;  
with four belts & two belts to be choose  
Inlet tube: O.D 11mm; 130cm length  
Sterilization: EO  
Form of packing: 1pc/Blister pack, 10pcs/carton  
Measurement of carton: 580x290x235mm



**GT029-400  
Leg Bag**

Capacity: 600ml  
Type: Square  
with blue pull-push valve & blue tip cover  
with anti reflux valve; with double high elastic belts  
Sterilization: EO  
Form of packing: 1pc/PE bag, 48pcs/carton  
Measurement of carton:  
300x260x150mm With 120cm tube



**GT029-430  
Leg Bag**

Capacity: 500 ml  
Type: ellipse shape  
with T valve & short outlet tube;  
with double high elastic belts  
Sterilization: EO  
Form of packing: 1pc/Blister pack, 100pcs/carton  
Measurement of carton: 380x260x230mm



**GT029-410  
Leg Bag**

Made of clear ,medical grade PVC  
Type:ellipse shape  
with green twist valve&green tip cover  
with anti reflux valve;  
with double high elastic belts  
Tube length:30cm,60cm,90cm (length can be customized)  
On the back of the bag body can be customized flocking or non-woven fabric  
Sterilization:EO  
Size available:500ml\600ml\ 750ml\ 1000ml  
Packing :Blister bag Or PE Bag



**GT029-410  
Leg Bag**

Capacity: 500ml & 1000ml  
Type: ellipse shape  
with green twist valve & green tip cover  
with anti reflux valve; with double high elastic belts  
Sterilization: EO  
Form of packing: 1pc/PE bag, 48pcs/carton  
Measurement of carton: 300x260x150mm



**GT029-420  
Leg Bag**

Capacity: 500 ml  
Type: ellipse shape  
with T valve & short outlet tube;  
with anti reflux valve  
Sterilization: EO  
Form of packing: 1pc/Blister pack, 100pcs/carton  
Measurement of carton: 550x400x325mm



**GT029-420  
Leg Bag(3 chambers)**

Made of clear ,medical grade PVC  
Type:ellipse shape  
with green twist valve&green tip cover  
with anti reflux valve;  
with double high elastic belts  
Tube length:30cm,60cm,90cm (length can be customized)  
On the back of the bag body can be customized flocking or non-woven fabric  
Sterilization:EO  
Size available:500ml,750ml  
Packing :Blister bag Or PE Bag



**GT029-500  
Disposable Pediatric Urine Collector**

1. Medical grade PVC material
2. For single use only. Discard after use
3. Do not store in direct sunlight, at extreme temperatures or in high humidity.
4. Do not use if package is open or damaged
5. Before use, the bottom should be pushed to the top of tight to avoid leakage

Size: General Type (Oval Sharp) 100ml/200ml  
For Girl Type (Mickey Mouse sharp) 100ml/200ml  
Anti-Reflux type 100ml/200ml  
Packing :PE Bag



# Foley Catheter

Made from natural latex

Silicone coated

Available with the option of plastic valve or rubber valve

Colour-coded for visualisation of size

## GT029-610

### Closed Wound Drainage System (Spring)

1. This product includes 3-spring evacuator, PVC tubing, Y connector, PVC drainage tube and stainless steel trocar.
2. The design of 3-spring evacuator minimizes the Collapse-Resistance.
3. The PVC drainage tube inside can be replaced by our other silicone drains, if needed.

Size available : 200ml,400ml,800ml(8Fr, 10Fr,12Fr, 14Fr, 16Fr, 18Fr,20Fr,22Fr,24Fr)  
Packed :Blister Bag

## GT029-620

### Closed Wound Drainage System (Hollow)

1. Aseptic PE material.
  2. Hollow non-spring wound drainage reservoir with PVC drainage tube and trocar, bed sheet clamp and robot clamp.
- Size available : 200ml,400ml(8Fr, 10Fr,12Fr, 14Fr, 16Fr, 18Fr, 20Fr,22Fr,24Fr)  
Packing :Blister Bag

## GT022-200 2-way Latex Foley Catheter

Made from natural latex

Silicone coated

Plastic valve or Rubber valve is available

Color-coated for visualization of size

Fr6-Fr10 (Pediatric)

Length:270mm Balloon Capacity:3cc/5cc

Fr12-Fr22 (Standard)

Length:400mm Balloon Capacity:5cc/10cc/30cc

Fr24-Fr26 (Standard)

Length:400mm Balloon Capacity:10cc/30cc

Packed in individual Blister bag

10pcs/box, 500pcs/ctn, Dimension:52X43X47.5 cm



## GT069-112

### Silicone Reservoir

Made of medical grade silicone  
Provided with internal anti-reflux valve  
Bulb silicone walls provide easy activation of suction  
Regular system is to be used together with silicone flat drains, but we also recommend innovative solutions which are combined with our round fluted drains or round perforated drains.  
Size:100ml,150ml,200ml,400ml  
Packing :Blister bag

## GT022-300

### 3-Way latex Foley Catheter

Made from natural latex

Silicone Coated

Plastic valve or Rubber valve is available

Used for clinical urine catheterization, injection and irrigation.

Length: 400mm

Size: Balloon Capacity

Fr16-Fr26 30cc

packing:Blister Bag



Round Fluted

Round Channel

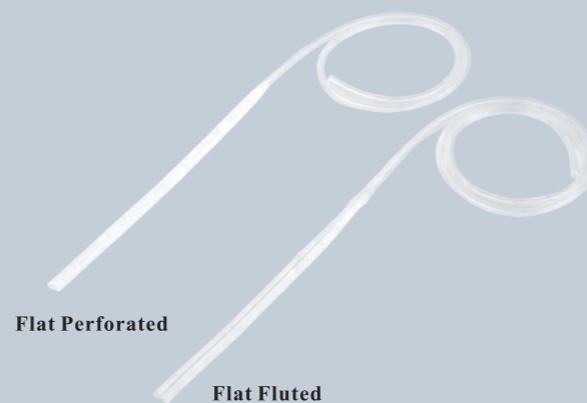

Flat Perforated

Flat Fluted

## GT069-112T

### Silicone Round Channel/Fluted Drains

Made of medical grade silicone  
Utilize internal channels or fluted, to swiftly remove exudate Independent channels facilitate drainage and reduce risk of occlusion Made by one time, no connector ensures patients' comfort upon removal Radio-opaque line through the length for X-ray visualization  
Available with or without "Three Face" stainless steel trocar  
Size and length can be customized  
Size:FR 10,FR 15,FR 19,FR 24,FR 28  
Packing :Blister bag

## GT022-400

### 2-Way Female Foley Catheter

Made from natural latex

Silicone Coated

Plastic valve or Rubber valve is available

Used for clinical urine catheterization of Female

Length: 260mm

Size: Balloon Capacity

Fr12-Fr26 30cc

packing:Blister Bag



## GT022-500

### 2-Way Tiemann Foley Catheter

Made from natural latex

Silicone Coated

Plastic valve or Rubber valve is available

Used for clinical urine catheterization of male

Length: 260mm

Size: Balloon Capacity

Fr12-Fr26 30cc

packing:Blister Bag



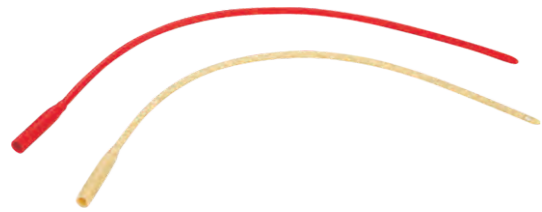

**GT022-100  
Urethral Catheter**

Made from natural latex  
Silicone Coated  
Plastic valve or Rubber valve is available  
Used for clinical urine catheterization  
Red Latex / Yellow Latex  
Size Length  
Fr8-Fr10 270mm  
Fr12-Fr30 400mm



**GT023-100  
Malecot Catheter**

Made from Natural Latex; Silicone Coated; Length:400mm; Used for Clinical bladder fistula operation urethral catheterization;  
10pcs/box, 200pcs/carton  
Red Latex / Yellow Latex  
FR14-FR32, FR12 and FR34-FR42 are also available for customer requests  
Packing: Individual Blister Bag



**GT022-900  
2- Way All Silicone Foley Catheter**

Made from high quality 100% silicone, medical grade  
With X-ray or without is available  
Fr8-Fr10 (Pediatric)  
Length:310mm Balloon Capacity:3cc/5cc  
Fr12-Fr26 (Standard)  
Length:400mm Balloon Capacity:5cc/10cc  
Fr16-Fr24 (Standard)  
Length:400mm Balloon Capacity:5cc/10cc/30cc  
Packed in individual Blister bag  
10pcs/box, 500pcs/ctn, Dimension:52X43X47.5cm



**GT022-200S  
Super Lubricating Foley Catheter**

Made from Natural Latex; Available With the option of plastic valve or rubber valve; Easy for inserting and hydrophilic coating to reduce the stimulation to mucous membrane of the urethra.  
Type: Single way; 2-way; 3-way; 2-way Female; 2-way Tiemann;  
size: Fr8-24 (Single way)  
Fr8-24 (2-way)  
Fr16-24 (3-way)  
packing: Individual Blister Bag

**GT022-900T  
Disposable All Silicone Foley Catheter with Temperature Sensor**

Made from High quality 100% silicone, medical grade;  
With X-ray or without is available;  
Detect temperature in the bladder,  
temperature range: 25°C-44°C, Accuracy: ±0.1°C  
Length: 400mm; Balloon Capacity: 3ml/5ml/ 10ml/ 15ml/ 30ml  
Fully compatible with most monitors. Temperature extension cable is available.  
Note: Do not pull hardily the Temperature measurement cord during using.  
Size: Fr8-24 (Color coded)  
Packing: Individual Blister Bag



**GT022-200T  
Self-Catheterization System**

Made from Non-toxic, Non-irritant soft Medical grade PVC; DEHP free is available; Component: Intermittent Catheter; PVC Gloves; Collection bag; Moisture-proof underpad; PVP Swabsticks (3/pkt), sterile.  
Features: Closed system specially designed reducing risk of contamination. The catheter and introducer are coated with a water soluble lubricant for ease of insertion. Catheter Guide allows for simple, protected control of catheter during insertion. 1500ml collection bag eliminates the need for separate container, reducing the chance of spillage.  
Size: Fr6-18 (Color coded)  
Packing: Individual Blister Bag



**GT025-100 T-Drainage Tube**

Made from natural latex, Silicone coated  
Used for the drainage of the operation of Cholecyst  
The connector part is larger in diameter than other parts  
Size: Fr10-Fr26  
Packed in individual Blister Bag



**GT024-100 Penrose Drainage Tube**

Made from natural Latex; Length: 450mm  
Size: 1/4", 5/16", 3/8", 1/2", 5/8", 3/4", 7/8", 1"



**GT026-100S  
Condom Catheter**

Made from high quality 100% Silicone, medical grade;  
Size: 24mm, 28mm, 31mm, 35mm, 40mm  
With/without adhesive tape  
Packing: Individual Blister Bag

**GT026-100 Condom Catheter**

Made from natural latex  
Size: 20mm, 25mm, 30mm, 35mm, 40mm  
Packing: Individual Blister Bag



**GT022-200CP Catheter Plug**

The Spigot is used to provide stop of flow for catheters hygienically during nursing procedures. It is non-invasive which has been utilized to seal the catheter for a short time to allow urine to collect in the bladder.  
• Made from non-toxic PP.  
• Universal size is molded to fit all sizes of catheters or tubes.  
• Graduated design make it to easily accommodate tubing of various internal diameters.  
• Ribbed designed provides strong, secure connections.  
• Ergonomic flanged design assists withdrawal and maximize grip.  
• EO Sterile, Single use only.  
• Total Length: 55.0±5.0mm Diameter: 12.0±1.0mm



# Endotracheal Tube

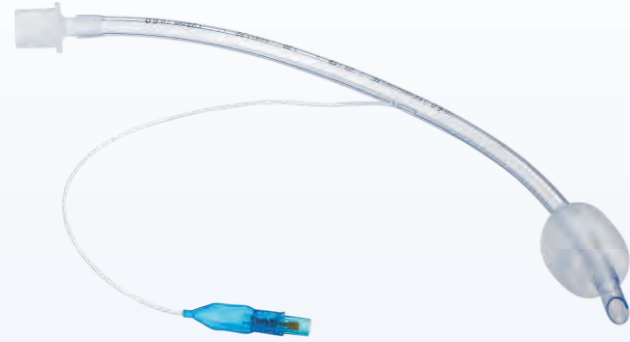

## GT014-100 Oral / Nasal Endotracheal Tubes

Made from non-toxic PVC, transparent soft and smooth; DEHP free is available; With Cuff; Available with Murphy eye; X-ray opaque line throughout the tube. High volume low pressure cuff and Standard low pressure cuff (suitable for Short-term operation intubation) are available.  
size: 2.5mm-10.0mm  
packing: Individual Blister Bag (Rectangular shape and Half-moon shape available)

## GT014-200 Oral / Nasal Endotracheal Tubes

Made from non-toxic PVC, transparent soft and smooth; DEHP free is available; Without Cuff; Available with Murphy eye; X-ray opaque line throughout the tube.  
size: 2.0mm-10.0mm  
packing: Individual Blister Bag (Rectangular shape and Half-moon shape available)



## GT014-300 Nasal Preformed Tracheal Tubes

Made from non-toxic PVC, transparent soft and smooth; DEHP free is available; With Cuff; Available with Murphy eye; X-ray opaque line throughout the tube. High volume low pressure cuff and Standard low pressure cuff (suitable for Short-term operation intubation) are available.  
size: 3.0mm-10.0mm  
packing: Individual Blister Bag

## GT014-400 Nasal Preformed Tracheal Tubes

Made from non-toxic PVC, transparent soft and smooth; DEHP free is available; Without Cuff; Available with Murphy eye; X-ray opaque line throughout the tube.  
size: 3.0mm-10.0mm  
packing: Individual Blister Bag

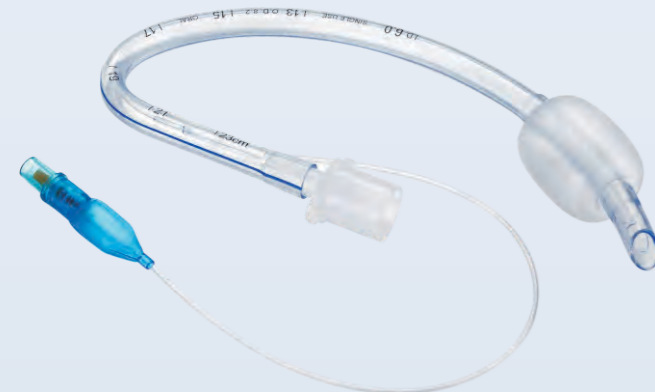

## GT014-500 Oral Preformed Tracheal Tubes

Made from non-toxic PVC, transparent soft and smooth; DEHP free is available; With Cuff; Available with Murphy eye; X-ray opaque line throughout the tube. High volume low pressure cuff and Standard low pressure cuff (suitable for Short-term operation intubation) are available.  
size: 3.0mm-10.0mm  
packing: Individual Blister Bag



## GT014-600 Oral Preformed Tracheal Tubes

Made from non-toxic PVC, transparent soft and smooth; DEHP free is available; Without Cuff; Available with Murphy eye; X-ray opaque line throughout the tube.  
size: 2.0mm-10.0mm  
packing: Individual Blister Bag

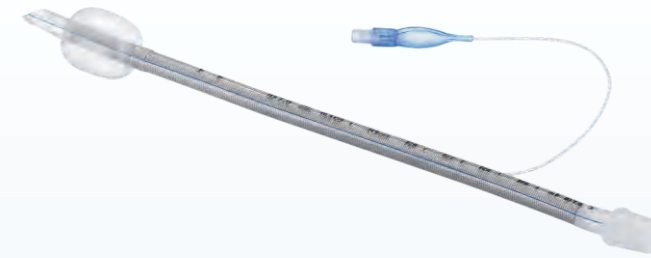

## GT014-700 Reinforced Endotracheal Tubes (Oral/Nasal) (With/Without Cuff)

Made from non-toxic PVC, transparent soft and smooth; DEHP free is available; Without Cuff; Available with Murphy eye; X-ray opaque line throughout the tube. With a spiral wire embedded in the tube to provide effective resistance for kinking. Bite block type is available.  
Size: 3.0mm-9.5mm  
Packing: Individual Blister Bag (Rectangular shape and Half-moon shape available)

## GT024-500 Suction Plus Endotracheal Tube (Endotracheal Tube with Evacuation Lumen)

1. Made from PVC in medical grade. DEHP is available.  
2. With a spiral wire embedded in the endotracheal tube provides effective resistance to kinking.  
3. High volume, low pressure cuff or Low Profile cuff  
Size ID: 6.0mm, 6.5mm, 7.0mm, 7.5mm, 8.0mm, 8.5mm, 9.0mm  
Packing: Individual Blister Bag



## GT024-600 Reinforced Suction Plus Endotracheal Tube (Reinforced Endotracheal Tube with Evacuation Lumen)

1. Made from PVC in medical grade. DEHP is available.  
2. With a spiral wire embedded in the endotracheal tube provides effective resistance to kinking.  
3. High volume, low pressure cuff or Low Profile cuff  
Size:  
PU Cuff Size ID: 6.0mm, 6.5mm, 7.0mm, 7.5mm, 8.0mm, 8.5mm, 9.0mm  
PVC Cuff Size ID: 6.0mm, 6.5mm, 7.0mm, 7.5mm, 8.0mm, 8.5mm, 9.0mm  
Packing: Blister Bag

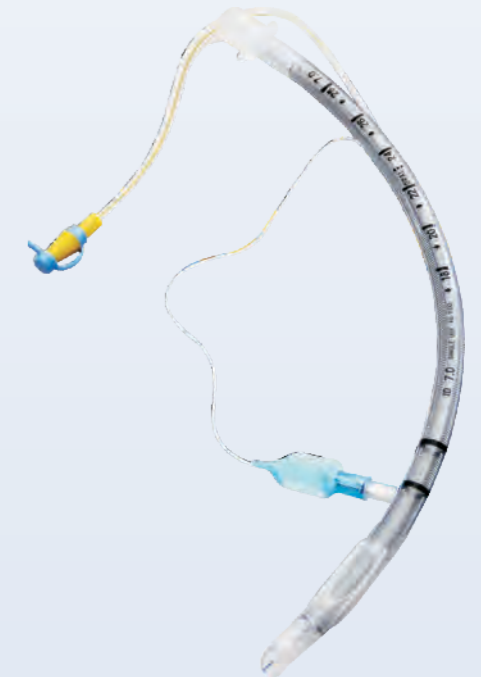

## GT024-700 Endobronchial Blocker Tube

Endobronchial blocker tube is a device which can be inserted down a tracheal tube after tracheal intubation so as to block off the right or left main bronchus of the lungs in order to be able to achieve a controlled one sided ventilation of the lungs in thoracic surgery. The lung tissue distal to the obstruction will collapse, thus allowing the surgeon's view and access to relevant structures within the thoracic cavity. Our blocker tubes are making attempts to achieve the one-sided lung ventilation as an alternative to Double-lumen tubes (DLT) and serve as a choice for pediatric patients as well.  
Size: Standard PU Cuff Type Size (mm) : 5FR, 7FR, 9FR  
Packing: Blister Bag

**GT024-800**  
**Double Lumen Endobronchial tube**

Endobronchial tube is used for the purpose of establishing and maintaining a patient airway and ensure the adequate exchange of oxygen and carbon dioxide.

**Features**

1. Made from PVC in medical grade. DEHP is available.
2. Equipped with switch connector and two low-friction suction catheters.
3. Available with two types, left-side and right-side.
4. The cuffs, two lumens and pilot balloons are imprinted with Tracheal (clear) or Bronchial (blue) for easy identification.
5. Smooth inner lumens can make the bronchoscopes easier to go through.
6. Pre-loaded stylet can help tube maintain the shape for easier intubation.

Size: Fr28, Fr32, Fr35, Fr37, Fr39, Fr41  
 Packing:Blister Bag, 1pc/box



**GT015-100 Tracheostomy Tube**  
 With cuff

SIZE:3.0-10.0MM  
 Packing:Hard Blister Pack



**GT015-200 Tracheostomy Tube**  
 Without cuff

SIZE:3.0-10.0MM  
 Packing:Hard Blister Pack

**GT014-800**  
**Endotracheal Tube Introducer (Bougie)**

Made from semirigid non-toxic Polyethylene  
 Used for assistance intubation  
 10pc/box

Size	Length
6	53.5cm
10	70cm
15	70cm

Size	Length
10	90cm
15	90cm

Packing:Blister Bag



**GT014-900**  
**Intubating Stylet**

Made of malleable aluminum covered with plastic sheath.  
 Soft rounded tip for minimizing patient trauma during intubation.  
 Flexible use for assistance of intubation.

Size	Length
6	30.2cm
10	38.2cm
14	38.2cm

Packing:Blister Bag

**GT014-100H**  
**Endotracheal Tube Holder**

The endotracheal tube holder is designed to provide a fast and secure fixation of the endotracheal tube after insertion in trachea.

**Features:**

- Keep an endotracheal tube in place without applying tape to the patients face
  - Accommodate multiple ET tubes
  - Bite block protects patient teeth and gums while keeping tube open
  - Allow in-use suctioning of the oropharynx
- Sterilization:EO  
 size:6MM-13MM  
 packing:Hard blister bag

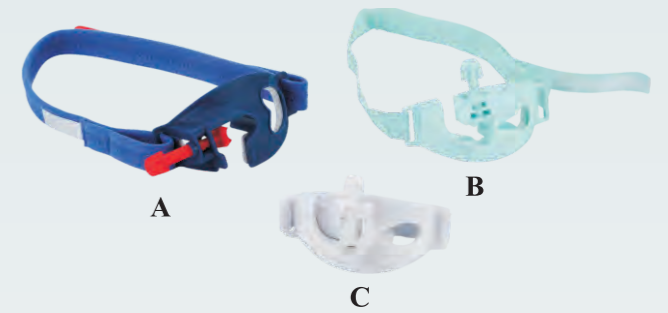

**GT014-100B**  
**Belt for ET Tube**

Material:plush+sponge+velcro  
 Size:Adult, Child.  
 Color:Blue  
 1pc/bag



**GT016-200**  
**Nasopharyngeal Airway**

Made from soft PVC  
 Nasopharyngeal airway is designed for easy insertion and maximum patient comfort.  
 It facilitates suctioning in intensive care ,general anaesthesia and also provide an alternative airway during emergency procedures.  
 Sterilization:EO  
 Size:1.D3.0MM-1.D9.0MM  
 Packing:Blister Bag



**GT016-100**  
**Guedel Airways(Guedel type)**

Made from semirigid non-toxic polyethylene  
 Color-coded bite block is designed for easy identification and to prevent biting down  
 Guedel style enclosed center channel  
 Sterilization:EO  
 size:000#,40mm,pink  
 00#,50mm,blue  
 0#,60mm,black  
 1#,70mm,white  
 2#,80mm,green  
 3#,90mm,yellow  
 4#,100mm,red  
 5#,110mm light blue  
 6#,120mm,orange  
 packing:Blister bag Or PE Bag



**GT016-100B**  
**Guedel Airways(Berman Type)**

Made from semirigid non-toxic polyethylene  
 Atraumatic one piece design for optimum patient comfort and safety  
 Rigid bite block to ensure airway patency  
 clear secretions and also provides space for oral care  
 Sterilization:EO  
 Size:40mm,50mm,60mm,70mm,80mm,90mm,100mm,110mm  
 Packing:Blister bag Or PE Bag







**GT029-700  
Disposable Silicone Laryngeal Mask**

Made of 100% medical grade silicone  
No poison and harmless  
Non-epiglottis-bar design provides easy and clear access through the lumen  
5 angular lines appear when the cuff is in flat status, which can avoid the cuff to deform during insertion  
Deep bowl of the cuff provides excellent sealing and prevent the obstruction caused by epiglottis ptosis  
Special treatment of the cuffs surface reduce leak and shift effectively  
Suitable for adult, children and infant use  
Sterilization:EO  
Size:1#,1.5#,2#,2.5#,3#,4#,5#  
Packing:Blister bag



**GT029-720  
Disposable PVC Laryngeal Mask**

Made of non-toxic medical grade PVC  
No poison and harmless  
Non-epiglottis-bar design provides easy and clear access through the lumen  
Special treatment of the cuff's surface reduce leak and shift effectively  
Suitable for adult, children and infant use  
Sterilization:EO  
Size:1#,1.5#,2#,2.5#,3#,4#,5#  
Packing:Blister bag



**GT027-740  
Multi-function Laryngeal Mask**

Made from Medical grade Silicone.  
Size:3# 4# 5#  
Packing:Individual Blister Bag

- The stomach tube can be inserted into the venthole;
- Cover capsule contains original designed sputum collection chamber;
- Unique design with cuff and back-cuff double capsule ensures good sealing, effectively prevent leakage and improve the aeration time;
- Connectors at both ends with fixed small handle, convenient fixed after laryngeal mask placement;
- The reasonable fixed guide intubation, supporting guide tube core, high success rate of intubation;
- Patient side drainage chamber changed to slope surface, reduce the placement process stimulation to mucous membrane of the patient;
- The narrower the vent near the machine end, with the unique design of cross connectors can do processing contents on the patients mouth

Size	Indicative Patient/Weight	Maximal Volume of Balloon	Remark
1#	<6	4	Newborn
1.5#	6-10	4	Infant
2#	10-20	5	Child
2.5#	20-30	12	Child
3#	30-50	20	Adult
4#	50-70	30	Adult
5#	70-100	40	Adult



**GT029-710  
Reusable Silicone Laryngeal Mask**

Made of 100% medical grade silicone  
No poison and harmless  
Non-epiglottis-bar design provides easy and clear access through the lumen Can be used for 40 times and sterilized by 121°C steam  
5 angular lines appear when the cuff is in flat status, which can avoid the cuff to deform during insertion  
Deep bowl of the cuff provides excellent sealing and prevent the obstruction caused by epiglottis ptosis  
Special treatment of the cuffs surface reduce leak and shift effectively  
Suitable for adult, children and infant use  
Sterilization:EO  
Size:1#,1.5#,2#,2.5#,3#,4#,5#  
Packing:Blister bag



**GT027-730  
Reinforced Silicone Laryngeal Mask**

Made of 100% medical grade silicone  
No poison and harmless  
Spiral reinforcement minimizes crushing or kinking  
Smooth transparent and kink-resistant tube  
Suitable for adult, children and infant use  
Sterilization:EO  
Size: 1#,1.5#,2#,2.5#,3#,4#,5#  
Packing:Blister bag



**GT025-200  
Umbilical Catheter**

Length:50cm, Made from Medical grade PVC, clear and soft.  
Designed for intermittent continuance access to the umbilical artery or vein of newly born or premature infant.  
Size:FR4,5,6,8(Color coded)  
Packing:Individual Blister Bag



**GT027-200  
Bulb tubing**

Length:30m, Compatible with various sizes suction machine as function for connecting.  
Size:ID:8-16MM  
Packing:Individual Box



**GT019-200  
Thoracic Catheter with Reducer Pipe**

Features: Made from Medical grade PVC, soft and clear.  
Radiopaque stripe to help confirm proper tube placement.  
Atraumatic rounded tip.  
Size:Fr24-32  
Packing:Individual Blister Bag



**GT019-200R  
Disposable Thoracic Catheter**

Fr16-34 PU+Aluminum  
needle, with X-ray, used to export CO2 in Lung, EO sterile  
Individual Blister Bag

# Connection Tube with Yankauer Handle



## GT027-100

Made from Medical grade PVC, clear and soft.  
Crown tip or Plain tip; With or without Vented; Three types connectors: Short type, Long type, and Trumpet type; Two types handle shape: Normal Yankauer handle, and Rugby shape handle.  
size: Diameter: 1/4", 3/16", 9/32" etc  
Length: 1.8M, 2M, 2.5M, 3.0M, 3.6M etc.  
packing: Individual Blister Bag

BUBBLE YANKUER

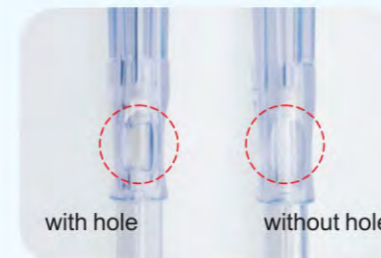

Code	Suction Tube	Yankauer Handle	Hole	Connector	Length
GT027-100-1	1/4Inch	Crown tip	with hole	Long connector	Length can be customized
GT027-100-2	1/4Inch	Crown tip	with hole	Short connector	Length can be customized
GT027-100-3	1/4Inch	Crown tip	with hole	Funnel connector	Length can be customized
GT027-100-4	1/4Inch	Crown tip	without hole	Long connector	Length can be customized
GT027-100-5	1/4Inch	Crown tip	without hole	Short connector	Length can be customized
GT027-100-6	1/4Inch	Crown tip	without hole	Funnel connector	Length can be customized
GT027-100-7	1/4Inch	Flat tip	with hole	Long connector	Length can be customized
GT027-100-8	1/4Inch	Flat tip	with hole	Short connector	Length can be customized
GT027-100-9	1/4Inch	Flat tip	with hole	Funnel connector	Length can be customized
GT027-100-10	1/4Inch	Flat tip	without hole	Long connector	Length can be customized
GT027-100-11	1/4Inch	Flat tip	without hole	Short connector	Length can be customized
GT027-100-12	1/4Inch	Flat tip	without hole	Funnel connector	Length can be customized
GT027-100-13	3/16Inch	Crown tip	with hole	Long connector	Length can be customized
GT027-100-14	3/16Inch	Crown tip	with hole	Short connector	Length can be customized
GT027-100-15	3/16Inch	Crown tip	with hole	Funnel connector	Length can be customized
GT027-100-16	3/16Inch	Crown tip	without hole	Long connector	Length can be customized
GT027-100-17	3/16Inch	Crown tip	without hole	Short connector	Length can be customized
GT027-100-18	3/16Inch	Crown tip	without hole	Funnel connector	Length can be customized
GT027-100-19	3/16Inch	Flat tip	with hole	Long connector	Length can be customized
GT027-100-20	3/16Inch	Flat tip	with hole	Short connector	Length can be customized
GT027-100-21	3/16Inch	Flat tip	with hole	Funnel connector	Length can be customized
GT027-100-22	3/16Inch	Flat tip	without hole	Long connector	Length can be customized
GT027-100-23	3/16Inch	Flat tip	without hole	Short connector	Length can be customized
GT027-100-24	3/16Inch	Flat tip	without hole	Funnel connector	Length can be customized



### GT017-100 Suction Catheter

Made from non-toxic, non-irritant soft PVC.  
DEHP-FREE is available.  
Distal end is opened with two lateral eyes,  
Four kinds of connectors available: T-type connector, Y-type connector, Cap-cone connector, Plain type connector,  
Color coded for size identification  
With X-ray or without is available  
Size: Standard Tube Length : 50cm  
Size: Fr5 - Fr24  
Packing:Blister Bag / PE Bag



Plain connector



Finger-control connector



Thumb control connector  
(T-type connector)



Y-type connector



Finger-control  
+plain connector



Transparent Y1 connector



Transparent Y2 connector



Transparent Y3 connector



### GT019-100 PVC Stomach Tube

Made from non-toxic, non-irritant soft PVC.  
DEHP-FREE is available.  
Printed with graduation.  
Color coded for size identification  
With X-ray or without is available  
Size: Standard Tube Length : 120cm  
Sterilization:EO  
Size: Fr6-Fr26  
packing:Blister Bag / PE Bag



### GT019-100B 100% Silicone Stomach Tube

Made of non-toxic, non-irritant 100% silicone  
Color: Transparent or translucent (Surface fog form)  
Provision of four eye-holes for efficient aspiration  
With X-ray line  
Tube length: 120cm  
Sterilization: EO  
Size: FR8-FR20  
Packing: Blister Bag



### GT017-100S Suction Catheter Kit

Made from Non-toxic, Non-irritant soft Medical grade PVC;  
DEHP free is available;  
with Normal saline;  
Four kinds of connector available: Plain connector,  
Finger-control connector,  
Thumb control connector, Y-type connector;  
With Gloves or Without Gloves is available;  
With X-ray or Without X-ray is available;  
Used for sputum suction.  
EO sterile.  
SIZE: Fr6-18 (Color coded)  
Packing: Individual Blister Bag / PE bag



### GT023-200 Closed suction catheter

Made of non-toxic, non-irritant PVC  
Features:  
Designed for removing bronchial secretions  
in intubated  
patients during mechanical ventilation  
Designed for 24 hours use  
Better control of infection  
Sterilization: EO  
SIZE: FR6-FR18  
packing: Blister Bag



### GT017-200 Extractor Mucus

Suitable for obtaining mucus specimen for microbiological examination Also suitable for aspiration of secretion from Dropharynx of new born babies to ensure free respiration  
Soft, frosted and kink resistant PVC tubing.  
Atraumatic, soft and rounded, open tip with two lateral eyes  
Clear transparent container permits visual examination of aspirate  
Spare screw top lid is provided to seal the container for safe transportation of specimen to the laboratory or aseptic disposal of container  
Size: Suction Tube lengths available: 35cm (Normal), 40cm, 50cm  
Capacity: 25ml  
Size: Fr6 - Fr14  
With/ Without polo filter membrane  
Packing: Blister Bag / PE Bag



Luer Lock Connector



### GT019-100D Ryle's Tube

Made of non-toxic, non-irritant PVC (Medical grade), or DEHP free or 100% silicone.  
Color: Transparent or translucent (surface fog form).  
With X-ray detectable thread.  
With metal ball.  
Connector (color coded) - Size (Fr/Ch):  
F6, F8, F10, F12, F14, F16, F18, F20, F22.  
Package: Single in PE or blister package.  
Sterilized by EO GAS.



### GT019-100C Duodenal Tube

Made of non-toxic, non-irritant PVC (Medical grade), or DEHP free or 100% silicone.  
Color: Transparent or translucent (surface fog form).  
With X-ray detectable thread.  
Closed distal end with four lateral eyes.  
Connector (color coded) - Size (Fr/Ch):  
F6, F8, F10, F12, F14, F16, F18, F20, F22.  
Package: Single in PE or blister package.  
Sterilized by EO GAS.



### GT020-100 Rectal Tube

Made of non-toxic ,non-irritant PVC  
 Color:Transparent or translucent(Surface fog form)  
 Closed tip with two lateral eyes  
 Color coded for size identification  
 With X-ray or without X-ray is available  
 Tube length:40cm  
 Sterilization:EO  
 DEHP Free is available  
 Size:FR20-FR36  
 Packing: Blister bag Or PE Bag



### GT021-100 Nelaton Catheter

Made of non-toxic ,non-irritant PVC  
 Color:Transparent or translucent(Surface fog form)  
 Closed tip with two lateral eyes  
 Color coded for size identification  
 Nelaton,tieman,male or female is available  
 With X-ray or without X-ray is available  
 Tube length:40cm for male;20cm for female  
 Sterilization:EO  
 DEHP Free is available  
 Size:FR6-FR24  
 Packing:Blister bag Or PE Bag



### GT030-200 Hydrophilic Zebra Guidewire

- Smooth surface ensures easier access through human's anatomical structure.
- Alternate color of blue and white guidewire provides high visualization under X-ray and endoscope.
- Super elastic nitinol material exhibits great kink-resistant property.
- Conical tip design makes it convenient to puncture in some circuitous place in the body.

ID:0.028",0.032",0.035"  
 Length: 150cm  
 Tip Shape: Straight



### GT030-100 Ureteral Stent Set

Can be with Closed or Open tip;  
 The radiopaque line facilitate the catheter location when visualized by X-ray;  
 Lateral Holes at the tube ensure much drainage and irrigation;  
 The Catheter with good biocompatibility;  
 The catheter without Mucosa stimulating infection;  
 Sterilized package for single use only.  
 Type:Single J Sent, Double J Sent.  
 Size:FR4.0,FR4.7,FR5.0,FR6.0,FR7.0,FR8.0



### GT030-100S Ureteral Stent Sets

Contents:Pigtail ureteral stent,advancer;  
 Can be with Closed or Open tip  
 The radiopaque line facilitate the catheter location when visualized by X-ray;  
 Lateral Holes at the tube ensure much drainage and irrigation;  
 The Catheter with good biocompatibility;  
 The catheter without Mucosa stimulating infection;  
 Sterilized package for single use only.  
 Size:FR4.0,FR4.7,FR5.0,FR6.0,FR7.0,FR8.0



### GT024-300 Dilation and Drainage Set

Dilation and drainage set is a surgical implement which used for dilation of a tract and drainage percutaneous nephrostomy.

#### Feature

The dilator is made from medical grade polymer material.  
 The drainage tube is made from medical grade silicone.  
 Good biocompatibility can minimize harm to human body.  
 Peeling sheath has suitable hardness and flexibility which can offer best maintenance during surgery.  
 Round tip of dilator can minimize trauma to human body.  
 Provide wide selections based on client's requirement.

#### Instruction for use

- 1.By introducing a guide needle into pyelo in percutaneous neparostomy.
  - 2.Withdrawing the core of guide needle.
  - 3.Introducing a guide wire through guide needle.
  - 4.Withdrawing the body of guide needle .
  - 5.Progressing from the smallest to the largest appropriate size by passing the dilator over the guide wire while maintaining the position the guide wire.
  - 6.The largest size dilator must be coated with peelig sheath.
  - 7.Withdrawing the guide wire and dilator,and maintaining the peeling sheath in the body.The surgery can be manipulated through peeling sheath.
  - 8.After surgery,the drainage tube can be positioned into body for drainage.
  - 9.Withdrawing peeling sheath.
- size:Fr6-Fr30



CE Approved

# Hypodermic & Accessories

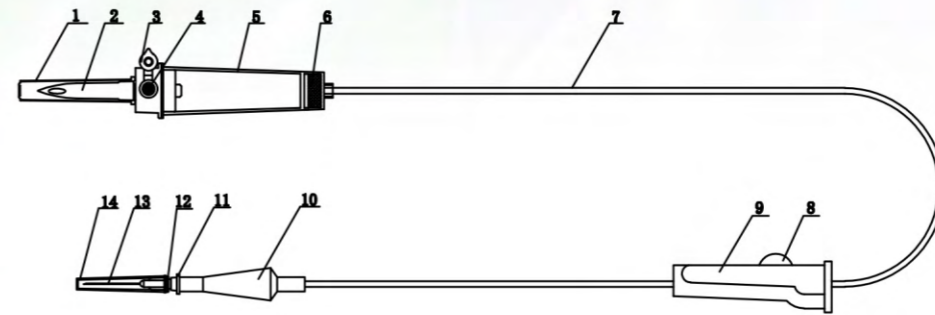

## GT034-100 Disposable Infusion Set

1	Vent Spike With Cap	PP
2	Spike	ABS
3	Air Vent	PVC
4	Air Filtration Membrane	PP
5	Drip Chamber	PVC
6	Filter	ABS+PA66
7	Tube	PVC
8	Roller Clamp	ABS
9	Flow Regulator	ABS
10	Rubber Gum Bubble	LATEX
11	Butterfly Two Way	ABS
12	Needle Stand	PP
13	Stainless Steel Needle	SUS304
14	Needle cover	PP

## GT034-101 Disposable Infusion Set

1	Vent Spike with Cap	PP
2	Spike	ABS
3	Air Vent	PVC
4	Air Filtration Membrane	PP
5	Drip Chamber	PVC
6	Filter	ABS+PA66
7	Tube	PVC
8	Roller Clamp	ABS
9	Flow Regulator	ABS
10	Injection Rubber Gasket	Polyisoprene Rubber LATEX FREE
11	Y site Injection Part	LATEX
12	Tube	PVC
13	Butterfly Two Way	ABS
14	Needle Stand	PP
15	Stainless Steel Needle	SUS304
16	Needle Cover	PP

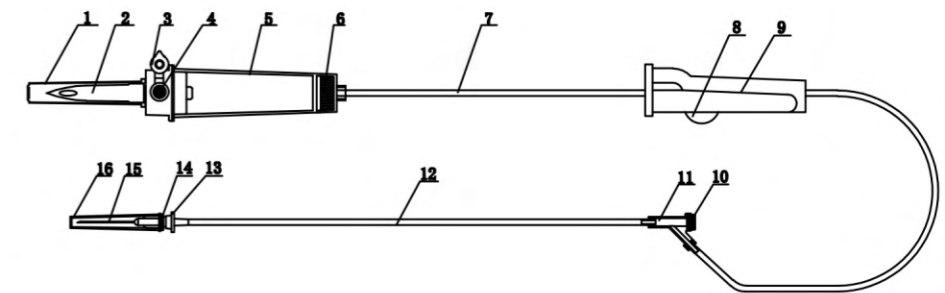

www.medicaltd-china.com



Yiwu Medica Import and Export Co., LTD  
 Add: Office #812, 8th Floor, Jiaheng Apartment, 1543 Chouzhou North Road, Futian Street,  
 Yiwu City, Jinhua City, Zhejiang Province, China  
 Tell/WhatsApp: +8615216877512  
 Email: info@medicaltd-china.com  
 Web: www.medicaltd-china.com

**GT034-102**  
**Disposable Infusion Set**

1	Vent Spike With Cap	PP
2	Spike	ABS
3	Air Vent	PVC
4	Air Filtration Membrane	PP
5	Drip Chamber	PVC
6	Filter	ABS+PA66
7	Tube	PVC
8	Roller Clamp	ABS
9	Flow Regulator	ABS
10	Injection Rubber Gasket	Polyisoprene Rubber LATEX FREE
11	Y Site Injection Part	LATEX
12	Tube	PVC
13	Two Way	ABS
14	Cap	PP

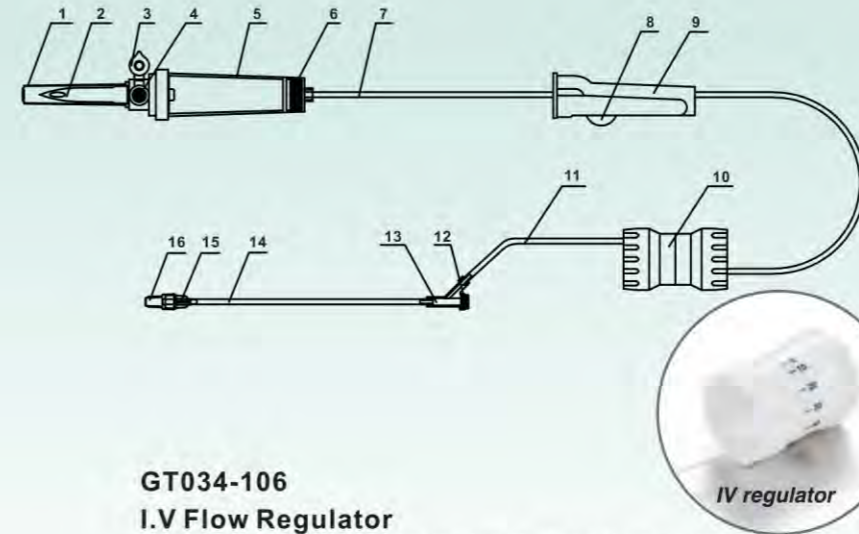
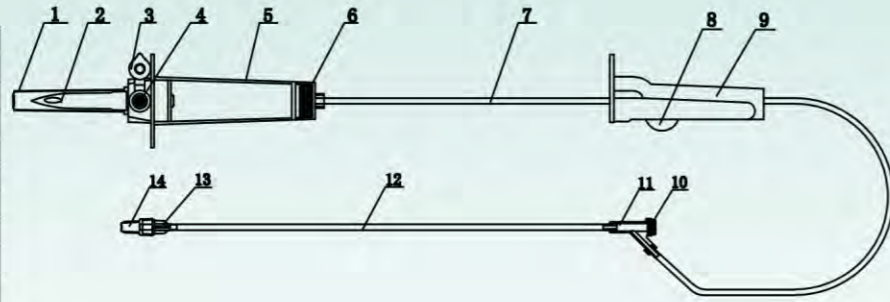

**GT034-106**  
**I.V Flow Regulator**

Precise Flow rate control of IV fluids with range of 5 to 250ml/hr  
With "Y" injection port (latex or latex free) for intermittent medication  
Also available with thumb support "Y" injection port and needle free "Y" site  
Male luer connector at one end and female luer connector at other end  
Standard tube length: 20cm without "Y" site & 40cm with "Y" site

**GT034-105**  
**Disposable Infusion Set**

1	Vent Spike with Cap	PP
2	Spike	ABS
3	Air Vent	PVC
4	Air Filtration Membrane	PP
5	Drip Chamber	PVC
6	Filter	ABS+PA66
7	Tube	PVC
8	Roller Clamp	PP
9	Flow Regulator	PP
10	IV regulator	ABS
11	Tube	PVC
12	Injection Rubber Gasket	Polyisoprene Rubber LATEX FREE
13	Y site Injection part	ABS
14	Tube	PVC
15	Two way	ABS
16	Cap	PE

**GT034-103**  
**Disposable Infusion Set**

1	Vent Spike With Cap	PP
2	Spike	ABS
3	Air Vent	PVC
4	Air Filtration Membrane	PP
5	Drip Chamber	PVC
6	Filter	ABS+PA66
7	Tube	PVC
8	Roller Clamp	ABS
9	Flow Regulator	ABS
10	Injection Rubber Gasket	Polyisoprene Rubber LATEX FREE
11	Y Site Injection Part	LATEX
12	Tube	PVC
13	Two Way	ABS
14	Cap	PP

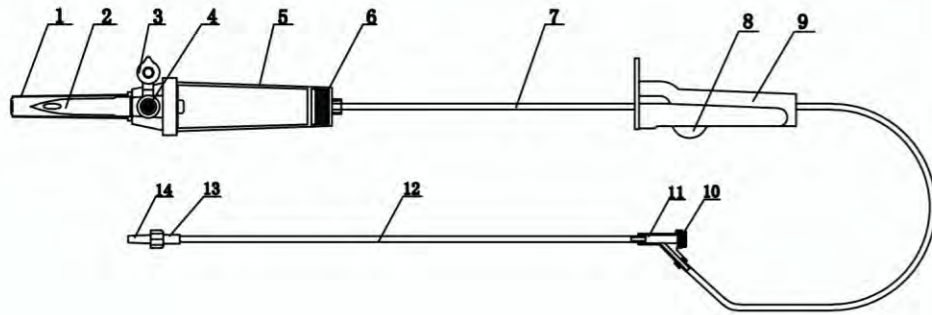

**GT034-200**  
**Disposable Burette Infusion Set**

1	Vent Spike with Cap	PP
2	Spike	ABS
3	Air Vent	PVC
4	Air Filtration Membrane	PP
5	Tube	PVC
6	Roller Clamp	PP
7	Flow Regulator	PP
8	Injection Rubber Gasket	Polyisoprene Rubber LATEX FREE
9	Air Vent	PVC
10	Drip Cap	ABS
11	Barrel	PETG
12	Float	Polyisoprene Rubber LATEX FREE
13	Drip Cap	ABS
14	60 Drops Drip	SUS304
15	Drip Chamber	PVC
16	Filter	ABS+PA66
17	Tube	PVC
18	Roller Clamp	PP
19	Flow Regulator	PVC
20	Injection Rubber Gasket	Polyisoprene Rubber LATEX FREE
21	Y site Injection Part	ABS
22	Tube	PVC
23	Two Way	ABS
24	Needle Stand	PP
25	Stainless Steel Needle	SUS304
26	Needle Cover	PP

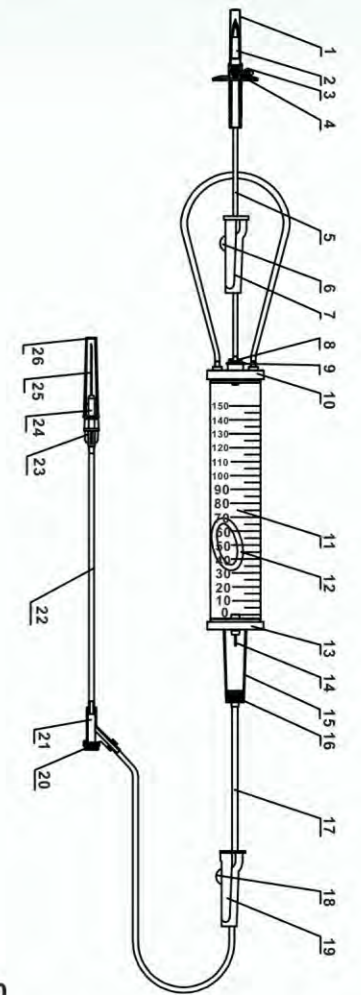

**GT034-104**  
**Disposable Infusion Set**

1	Vent Spike With Cap	PP
2	Spike	ABS
3	Air Vent	PVC
4	Air Filtration Membrane	PP
5	Drip Chamber	PVC
6	Filter	ABS+PA66
7	Tube	PVC
8	Auxiliary Clamp	POM
9	Anti-Reflux Valve	ABS
10	Tube	PVC
11	Injection Rubber Gasket	Polyisoprene Rubber LATEX FREE
12	Injection Plastic Part	ABS
13	Roller Clamp	ABS
14	Flow Regulator	ABS
15	Tube	PVC
16	Tube	PVC
17	Two Way	ABS
18	Cap	PE

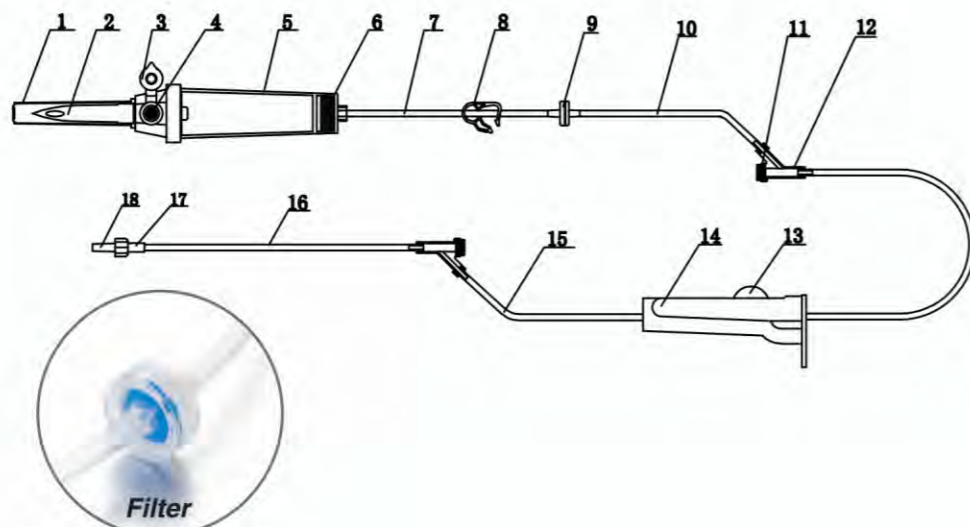

**GT035-100**  
**Disposable Blood Transfusion Set**

1	Vent Spike With Cap	PP
2	Spike	ABS
3	Air Vent	PVC
4	Air Filtration Membrane	PP
5	Drip Chamber	PVC
6	Filter	ABS+PA66
7	Tube	PVC
8	Roller Clamp	PP
9	Flow Regulator	PP
10	Rubber Gum Bubble	LATEX
11	Butterfly Two Way	ABS
12	Needle Stand	PP
13	Stainless Steel Needle	SUS304
14	Needle Cover	PP

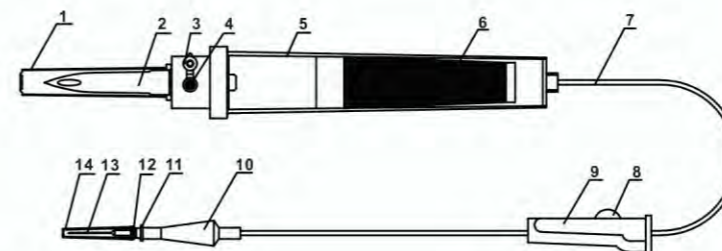



**GT039-100  
Stopcock Three way**

Parts:Body(PC),Plug(PE);Screw cap(ABS)  
Cold and heat tests, and the products will not have the phenomenon of crack  
Test pressure: 5.5kg.  
Products Thread: 6:100 screw thread standard, this in line with international GB standards.  
1000pcs/58x38x38cm

**GT039-200  
Heparin Cap**

Size: Standard  
Type: A:Yellow  
B:Transparent  
C:Octagonal  
Material: PC  
Sterile: EO



**GT033-200  
Infusion Extension Tube**

Length: 10CM,15CM,20CM, 25CM....300CM

**GT033-300  
T Shape Extension Tube**

Length: 10CM,15CM,20CM, 25CM....300CM

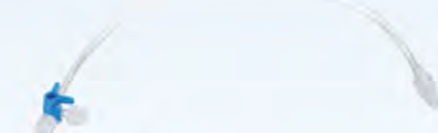

**GT039-300  
Combi Stopper**

Size: Standard  
Material: ABS  
Sterile: EO  
Fitted with male Luer lock at one end for safe and secure connection and the three way stop cock at the other end  
packing:1pc/blister, 100pcs/box, 50boxes/ctn

**GT039-300A  
Screw Cap**

**GT033-400  
Back Check Valve**

Type: Male to Female;  
Tube to Female; Tube to Tube;  
Tube to Male

**GT033-100  
Three Way Stopcock  
with Extension Tube**

Tube Size: 10cm, 15cm, 20cm, 25cm....300cm  
Parts: Body(PC),Plug:(PC),Screw Cap(ABS)  
Tube (medical Grade PVC),Connector(ABS)  
Products Thread:100 Screw Thread Standard, This Is Line With International Gb Standards  
Usage: Connect With Infusion Set, Extend Infusion Tube, Fitted With Male Luer Lock At One End For Safe And Secure Connection and The Three Way Stop Cock At the Other End  
Sterile: EO



**GT033-500  
Stopcock Three Way**

Type: Single Platoon(two way/three way)/Double Platoon/Triple Platoon/with connection tube  
High Pressure Platoon Stopcock Three Way  
Type: Double Platoon, Triple Platoon,  
Triple Platoon with extension tube, Quadruple Platoon Low Pressure Platoon Stopcock Three Way  
Type: Double Platoon, Triple Platoon



**GT033-600  
Stopcock**

Size: Standard  
Type: Single Platoon(two Way/three Way)  
/double Platoon/Triple Platoon  
/with Connection Tube  
Color: White(artery)blue(intravenous)  
White(others)



**GT033-700  
Needle Free Connector**

Size: Standard  
Type: Straight/Y type/intubation  
A: Y-site Needle free connector  
B: Needle free connector luer lock  
C: Needle free connector with tube

**GT033-800  
Extension Line with Positive Pressure Needle Free Connector**

- More Positive and more gentle flushing, safer for venous intima.
- No Leakage under 100 kPa/300kPa
- Biomedical grade silicone, safer than latex

Product Description	Mpa
1-way 1.3x2.3mm	100kPa
2-way 1.3x2.3mm	
3-way 1.3x2.3mm	
1-way 1.3x2.3mm,with check valve	300kPa
2-way 1.3x2.3mm,with check valve	
3-way 1.3x2.3mm,with check valve	



**GT037-100  
Disposable Syringe**

Material:PVC  
Parts:Barrel+Piston+Plunger +Needle(or without needle)  
Parts:Barrel+Plunger +Needle(or without needle)  
Luer Lock or Luer Slip / 2 parts or 3 parts  
1ml 3000PCS/59x44x45cm / 3ml 3000PCS/59 x44x45cm  
5ml 2400PCS/56x44x46.5cm / 10ml 1200PCS/56x44x46.5cm  
20ml 800PCS/59x44x44cm / 60ml 400PCS/59x44x44cm



**GT038-100  
Disposable Needle**



**GT038-101  
Disposable Safety Needle**

Specification		Color
mm	Gauge	
0.8x40mm	21Gx1 1/2"	Deep Green
0.8x50mm	20Gx2"	Deep Green
0.9x16mm	20Gx5/8"	Yellow
0.9x25mm	20Gx1"	Yellow
0.9x30mm	20Gx11/4"	Yellow
0.9x40mm	20Gx11/2"	Yellow
0.9x50mm	20Gx2"	Yellow
1.1x25mm	19Gx1"	Cream
1.1x30mm	19Gx11/4"	Cream
1.1x40mm	19Gx11/2"	Cream
1.1x50mm	19Gx2"	Cream
1.2x25mm	18Gx1"	Pink
1.2x30mm	18Gx11/4"	Pink
1.2x40mm	18Gx11/2"	Pink
1.2x50mm	18Gx2"	Pink
1.5x20mm	17Gx3/4"	Red-Blue
1.5x50mm	17Gx2"	Red-Blue
1.6x25mm	16Gx1"	White
1.6x40mm	16Gx11/2"	White
1.8x40mm	15Gx11/2"	Bulu-Grey
1.8x50mm	15Gx2"	Bulu-Grey
2.0x70mm	14Gx24/5"	Light Green
2.0x120mm	14Gx44/5"	Light Green



**GT037-200  
Tuberculin Syringe**

Size: 0.5ml, 1ml  
 Material: Medical PP (barrel And Plunger )  
 Latex/latex Free (piston)  
 Stainless Steel ( Needle)  
 Sterilized By Eo Gas  
 Individually Packing: Pe Bag (polybag) Or Blister Packaging.  
 Inner Packing: Box/polybag  
 Outer Packing: Corrugated Carton

**GT037-300  
Insulin Syringe**

Size: 0.3ml,0.5ml,1ml  
 Material: Medical Pp(barrel And Plunger )  
 Latex/latex Free (piston)  
 Stainless Steel( Needle)  
 Scale: 40/100u  
 With Fixed Needle 29g/30g  
 With Fixable Cap Or Removable Cap  
 Sterilized By Eo Gas  
 Individually Packing: Pe Bag (polybag) Or Blister Packaging.  
 Inner Packing: Box/polybag  
 Outer Packing: Corrugated Carton



**GT037-400  
Saftly Auto Destructive Syringe**

Size: 0.05ml, 0.1ml, 0.5ml  
 Material: Medical PP (barrel And Plunger )  
 Latex/latex Free (Piston)  
 Stainless Steel ( Needle)  
 Individually Packing: Blister Packaging.  
 Inner Packing: Box/Polybag  
 Outer Packing: Corrugated Carton

**GT037-500  
Saftly Auto Destructive Syringe**

Size: 2ml, 3ml, 5ml, 10ml  
 Material: Medical PP(barrel And Plunger )  
 Latex/latex Free (Piston)  
 Stainless Steel ( Needle)  
 Individually Packing: Blister Packaging.  
 Inner Packing: Box/Polybag  
 Outer Packing: Corrugated Carton



**GT037-600  
Safe Clip Syringe**

Size:1ml, 3ml, 5ml, 10ml, 20ml  
**Operation procedure**  
 ① Fix the clip before drawing.  
 ② Same operation as normal syringe in drawing and injecting  
 ③ After injection, push the clip over the needle and lock it onto the clip base

**GT037-700  
Safe Syringe**

Size: 0.5m, 1ml, 3ml, 5ml, 10ml  
 Material: Medical PP(Barrel And Plunger )  
 Latex/latex Free (Piston)  
 Stainless Steel ( Needle)  
 Individually Packing: Blister Packaging  
 Inner Packing: Box/Polybag  
 Outer Packing: Corrugated Carton



**GT038-900  
Insulin Needle**

Needle Size	Needle length	Package
30G	8mm	100pcs/box
31G	8mm	100pcs/box
31G	6mm	100pcs/box
31G	5mm	100pcs/box
32G	4mm	100pcs/box
33G	4mm	100pcs/box

**GT038-500  
Scalp Vein Set**

Type: Single Wing, Double Wings

Needle O.D(mm)	Color	Needle O.D(mm)	Color
0.3	Yellow	1.1	Milky white
0.33	Red	1.2	Pink
0.36	Bluish Green	1.4	Redish Purple
0.4	Grey	1.6	White
0.45	Brown	1.8	Bluish Grey
0.5	Orange	2.1	Light Green
0.55	Purple	2.4	Purple
0.6	Dark Blue	2.7	Light Blue
0.7	Black	3.0	Greenish Yellow
0.8	Dark Green	3.4	Greenish Brown
0.9	Yellow	-	-





## GT038-700

### I.V. Cannula

Needle size: 14, 16, 18, 20, 22, 24G

I.V. Cannula with Injection port and suturable wings

I.V. Cannula with suturable wings

I.V. Cannula with Injection port and without Wings

Option Available :

- PTFE / FEP / PU Flex Catheter
- Hydrophobic filter
- Clear or Radio Opaque Catheter

Advantage of using PU Flex Catheter :

- Kink free
- The Catheter softens once inserted in the body
- The properties of this Catheter are similar to PU (Polyurethane)

### FEATURES:

Japanese Needle with 3-facet Needle point to reduce penetration force

Kink resistant and specially tapered Catheter for easy vein puncture with minimum trauma

Transparent flash back chamber for easy visualization

of blood to confirm venipuncture

With Luer Lock plug

Colour coding for each gauge as per International standards

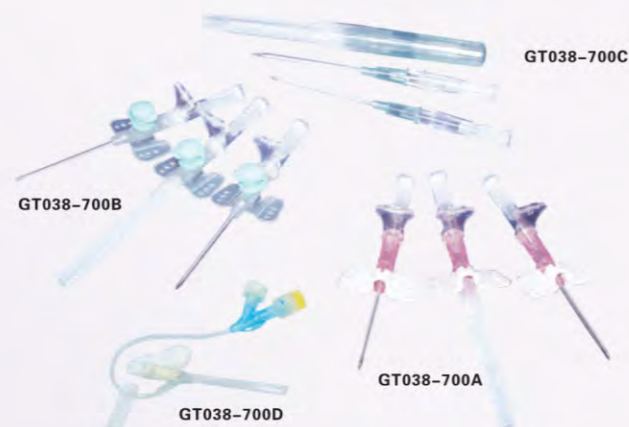

Size	Colour	Catheter (mm)		Catheter Length (mm)	Water Flow Rate (ml / min)
		I.D	O.D		
14 G	Orange	1.7	2.1	45	270
16 G	Grey	1.3	1.7	45	180
17 G	White	1.1	1.5	45	125
18 G	Green	0.9	1.3	32 / 45	80
20 G	Pink	0.8	1.1	32	54
22 G	Blue	0.6	0.9	25	33
24 G	Yellow	0.5	0.7	19	20



## GT054-200 Tourniquet

Adult (45x2.5cm)  
Color: Blue, Pink, Yellow, Purple, Green, Orange, Red Etc  
Children(38x2.5cm)  
Color: Blue, Pink, yellow, Purple, Green, Orange, Red Etc  
Button: Abs  
Belt: Terylene+elastic Rubber  
Length:45cm x Width: 2.5cm  
Stretch Length: 80-90cm  
Packing: 1pc/pp Bag,50 Pcs/ctn, 600 Pcs/ctn, 57 x 38x37cm



## GT054-100

### Latex-free Tourniquet

Width: 3/4";1"  
Thickness: 0.06mm  
Length:18"  
Color: Blue, Yellow, Green

### TPE Tourniquet

Width: 3/4";1"  
Thickness: 0.06mm  
Length:18"  
Color: Blue, Yellow



## GT055-100 Latex Tube

I.D.: 3.0-8.0  
O.D.: 5.0-12.0  
Length: 20m,25m

## GT038-300

### Spinal Needle

Type: Pencil Point; Quincke Tip

Length: 90mm

Guide needle is available

Size	18G	19G	20G	21G	22G	23G	24G	25G	26G	27G
Quincke	Pink	White	Yellow	Green	Black	Blue	Purple	Orange	Brown	Grey
Pencil Tip	/	/	/	/	Black	Blue	Purple	Orange	Brown	Grey



## GT038-400

### Epidural Needle

#12 - #18(18G - 15G) L65 - 150 mm  
Needle material: stainless steel  
Needle hub: transparent PP  
Color coded hub for size identification  
Packed in individual Blister Bag  
1000pcs/ctn, Dimension: 42X27X52cm

## GT038-410

### Epidural Catheter

## GT038-420

### Connect Adapter Luer Lock



## Anesthesia Kit (Mini)



Accessories	900-E/S	900-E	900-S
Epidural needle	16G/18G 80mm/90mm	Same	
Spinal needle	25G/27G 113/123MM(Pencilpoint)		20G/22G/25G
Epidural catheter	Pull-resistance length > 90cm	Same	
Epidural Catheter adapter	One	Same	
Liquid medicine filter	( blue ) 5 μ	Same	Same
Air filter	( Yellow ) 0.5μ	Same	
LOR Syringe	One Glass 5ml	Same	Same
Plastic Syringe	Two(3ml and 20ml)	1 pc 20ml	1 pc 5ml
Syringe needle	One OD 0.5mm L20mm One OD 0.7mm L32mm One OD 1.6mm L38mm	Same	Same

# Disposable Infusion Pump

## GT034-300

Infusion Pump:

Patients in clinical analgesic therapy with this product to relieve or ease the pain.

Infusion pump is disposable medical device, which takes the Silicone tube tension as power, through the capillary pores current limit, so as to achieve the aim of safe and effective uniform drug delivery analgesia.

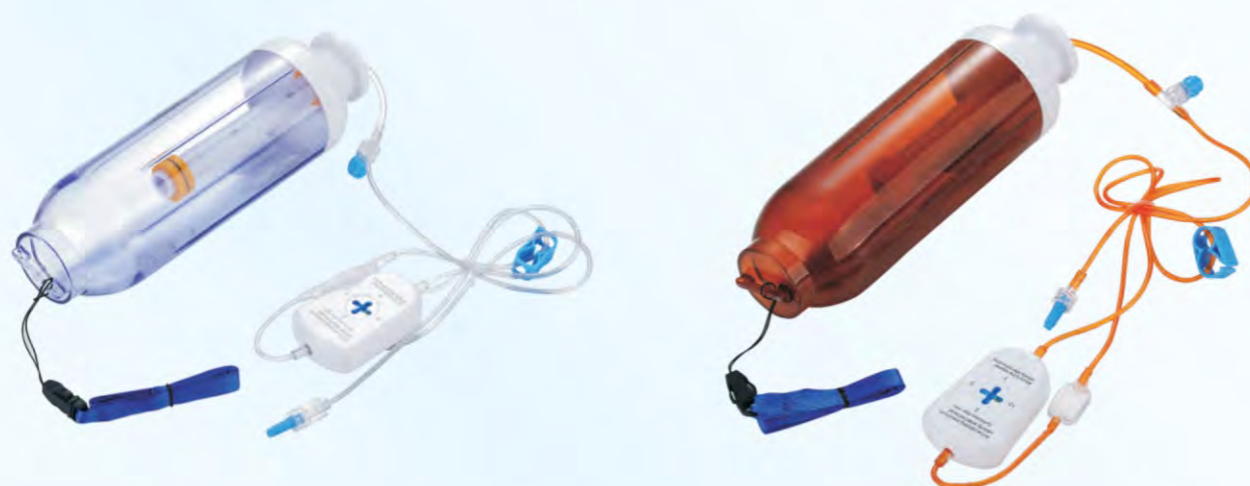

TYPE	Volume	Flow Rate	Lockout Time	Bolus Volume
Multi-rates CP Pump	60ml,100ml,150ml, 200ml,275ml,300ml	2ml/h, 4ml/h 6ml/h, 8ml/h	10min/15min	0.5ml
Multi-rates CP Pump	60ml,100ml,150ml, 200ml,275ml,300ml	2, 3, 4, 5ml/h 2, 4, 6, 8ml/h 4, 6, 8, 10ml/h 6, 8, 10, 12ml/h		
CP Pump	60ml,100ml,150ml, 200ml,275ml,300ml	2ml/h, 3ml/h 4ml/h, 5ml/h	10min/15min	0.5ml
CP Pump	60ml,100ml,150ml, 200ml,275ml,300ml	0.5ml/h, 1ml/h, 2ml/h, 3ml/h 4ml/h, 5ml/h, 6ml/h		

- **CBI Disposable Infusion Pump:** Using elasticity of silica gel sac implements infusion solution, using current-limiting device implements flow rate control, so as to erase pain after operation.
- **CBI Multi-velocity Infusion Pump:** Multi-velocity infusion pump is a new upgraded product, it owns 4 different velocity within one pump, doctors can adjust according to clinical need.
- **CBI+PCAMulti-velocity Infusion Pump:** Multi-velocity infusion pump is a new upgraded product, it owns 4 different velocity within one pump, doctors can adjust according to clinical need. Meanwhile, it owns self-control dosing function, doctors can dosing according to the patients' conditions.
- **CBI+CPA Disposable Infusion Pump:** Using elasticity of silica gel sac implements infusion solution, using current-limiting device implements flow rate control, so as to erase pain after operation. Meanwhile, it owns self-control dosing function, doctors can dosing according to the patients' conditions.

# Anesthesia Kit



Accessories	800-E/S	800-E	800-S
Epidural needle	16G/18G 80mm/90mm	Same	
Spinal needle	25G/27G / 113/123mm(Pencilpoint)		20G/22G
Epidural catheter	Pull-resistance length > 90cm	Same	
Epidural Catheter adapter	One	Same	
Liquid medicine filter	(blue)5 μ	Same	Same
Air filter	( Yellow)0.5μ	Same	
LOR Syringe	One Glass 5ml	Same	Same
Plastic Syringe	Two(3ml and 20ml)	1 pc 20ml	1 pc 5ml
negative pressure tube	one	one	
fenesrated sheet	60cm x 60cm hole 10cm	Same	Same
Small Nonwoven sheet	1 pc 50cm x 50cm	Same	Same
Big Nonwoven sheet	1pc 70cm x95cm	Same	Same
Catheter adhesive silce	One	Same	
Adhesive traps	One 5cm x 40cm , 2pc-1.25cm x 10cm	Same	
Compresses	Two 8 plyers 8cm x 10cm, one 5 x6 with cut	Same	Same
Sponge brush	Three(curving/Straight)	Same	Same
Surgical latex gloves	One pair 7.5/7.0/6.0	Same	Same
Syringe needle	One OD 0.5mm L20mm One OD 0.7mm L32mm One OD 1.6mm L38mm	Same	Same



### GT048-100 Surgical Gloves

Description :sterilized Surgical Gloves  
( Sterile By Gamma Ray).  
Powdered or powder-free  
(material): made Of Natural Latex.  
Found As Follows:  
Products Technical Datas:  
Quality:

#### Specification (mm):

Size	6mm	6.5mm	7mm	7.5mm	8mm	8.5mm	9mm
Length (min,mm)	260	260	270	270	270	280	280
Width (min,mm)	77±5	83±5	89±5	95±5	105±6	108±6	114±5

Before Aging After Aging  
(70'cx168hours)tensile Strength (n) ≥ 12 9  
Packing:packed In Cartons And In Good Condition.  
Packing: 50Pairs/box 500Pairs/ctn, 67 X 26 X 40cm 15/13 Kgs



### GT050-100 Vinyl Gloves

Material: Vinyl  
Product Name: Vinyl Gloves  
Grade: AQL4.0  
General Specificatio

Size	Glove Length	Palm Width	Thickness	Content of Powderful
X-Large	240±10mm	14±3mm	0.08±0.01mm	0.1-0.2g
Large	240±10mm	106±3mm	0.08±0.01mm	0.1-0.2g
Middle	240±10mm	106±3mm	0.08±0.01mm	0.1-0.2g
Small	240±10mm	106±3mm	0.08±0.01mm	0.1-0.2g

#### We can make different weight as following:

S: 3.0g, 3.5g, 4.0g, 4.5g Etc  
M: 3.5g, 4.0g, 4.5g, 5.0g Etc  
L: 4.0g, 4.5g, 5.0g, 5.5g Etc  
XL: 4.5g, 5.0g, 5.5g, 6.0gEtc  
Packing: 100pcs/box, 1000Pcs/ctn, 31.5 X 24.5 X 25cm

### GT051-100 Nitrile Examination Gloves

Description :nitril Examination Gloves.  
Size: XI Arge Large, Medium, Small  
Description: Powdered Or Powder-free  
Products Technical Datas:  
1 ) specification (mm):

Size	XL	L	M	S
Length (min,mm)	230±10	230±10	230±10	230±10
Width (min,mm)	110±10	100±10	95±10	80±10
Thickness Single(mm)	≥0.08	≥0.08	≥0.08	≥0.08

Physical Properties (mm): 26pcs Sampled.  
Before Aging After Aging  
(100'cx22hours) 14.0 13.0  
Tensile Strength (mpa)  
Ultimate Elongation(%) 520 410  
Packing: 100pcs/box, 2000pcs/carton,  
53x27x36cm 18/16kgs



### GT049-100 Latex Examination Gloves

Size: Large, Medium, Small  
Description: Powdered Or Powder-free  
Material: Made Of Natural Latex  
Products Technical Datas:  
Specification (mm):

Size	L	M	S
Length (min,mm)	230±10	230±10	230±10
Width (min,mm)	110±10	95±10	80±10
Thickness Single(mm)	≥0.08	≥0.08	≥0.08

Physical Properties (mm): 26pcs Sampled.  
Before Aging After Aging  
(100'cx22hours)tensile Strength (mpa) 21.0 16.0  
Ultimate Elongation(%) 700 500  
Packing: 100pcs/box,2000pcs/53x27x32cm 18/16kgs

### GT049-101 Gynecology Examination Gloves

Material: Natural Latex  
Size: S,M,L  
Type: Sterile, Powdered, Powder-free  
Packing: Paper-Paper Bag

Dimensions	Standards	
	Ideal Medical Glove	En455
Length(mm)	450mm	400mm
Width(mm)		
Small	83±6mm	83±6mm
Medium	95±6mm	95±6mm
Large	108±6mm	108±6mm
Thickness-Single Wall(mm)		
Fingers	>0.2mm	>0.1mm
Palm	>0.16mm	>0.1mm
Cuff	>0.12mm	>0.1mm

#### Physical Properties:

Property	Standards	
	Ideal Medical Gloves	ASTM D6319(00)
Elongation at break(%)		
Before Aging	Min 750%	Min 700%
After Aging	Min 550%	Min 500%
Tensile Strength(MPa)		
Before Aging	Min 25MPa	Min 24MPa
After Aging	Min 19MPa	Min 18MPa

### GT052-100 PE Gloves

MATERIAL: Recycled or virgin polyethylene.  
Thickness: 0.018mm, 0.02mm, 0.022mm etc.  
Size: L, M, S  
Type: HDPE or LDPE, plain or embossed  
Color: white. Blue, pink etc.  
Different thickness, sizes,  
color and packings is available.

### GT053-100 Latex Powder-free Finger Cots And Powdered

Latex Powder-free Anti-static Finger Cots.  
Designed With A Proprietary Anti-static Agent That Yields Average Surface Resistance Of 108-11Ω Ohms Per Square Surface Unit.  
It Virtually Eliminate Electro Static Discharge.  
These Finger Cots Are Clean Processed And To Protect Particulatates, Chemicals And Solvents With Skin.  
Type: Smooth Surface With Rolled, Unrolled Or Cut Is Available.  
Specification Size ±3mm

	L	M	S
Length(mm)	65	65	65
Width(mm)	29	27	25
Thickness(mm)	0.13	0.13	0.13

Packing: 100Pcs/bag, 30000Pcs/ ctn, 45 X 45 X 30cm



### GT060-101 Two Fingers Cots

1.2gm/pc, white  
Package: 1pc/bag, 100bag/inner bag,  
5000/carton  
Carton size: 400x320x27mm





**GT040-100  
Disposable Surgical Blade**

Size: 10#,10A#,11#,12#,15#.20#,21#,22#,23#,24#  
Material: Carbon steel or stainless steel  
Packing: 1pc/Aluminium Foil Bag,  
100or200pcs /box, 5000pcs/ctn



**GT042-100  
Blood Lancet**

Stainless steel Blood lancet  
Length: 40mm



**GT040-300  
Skin Graft Blade**

Size: 158mm  
Material : Carbon Steel Or Stainless Steel  
Packing: 1pc/Aluminium Foil Bag,  
100pcs /box, 5000pcs/ctn

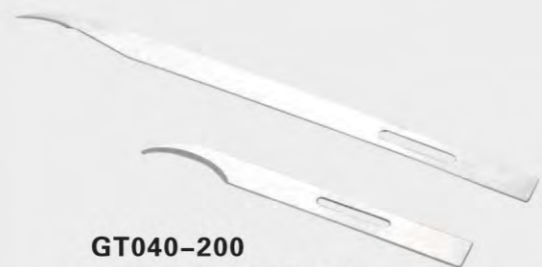

**GT040-200  
Stitich Cutter Blade**

Size: 65mm, 110mm  
Material : Carbon Steel Or Stainless Steel  
Packing:1pc/Aluminium Foil Bag,  
100pcs /box, 5000pcs/ctn



**GT042-200  
Plastic Handle Lancet--Twist Top**

Size	21G	23G	26G	28G	30G
Color	Orange	Green	Yellow	Pink	Purple

Sterilized by Gamma  
Packing: 100pcs/box, 20000pcs/ctn



**GT042-202  
Softclix Blood Lancet**

Plastic handle Flat Lancet

Size	28G	30G
Color	White	White

Sterilized by gamma  
Packing: 100pcs/box,20000pcs/ctn



**GT041-100  
Disposable Scalpel**

Size:10#-36#  
Material : Carbon Steel Or Stainless Steel  
Packing:1pc/aluminium Foil Bag,  
10pcs /box,500pcs/ctn



**GT041-200  
Safety Surgical Scalpel**

Size:10#-36#  
Material: Carbon Steel Or Stainless Steel,  
Sterilized By Gamma  
Packing:1pc/aluminium Foil Bag,  
10pcs/box,500pcs/ctn



**GT043-302  
Sterile Safety Lancet**

Size	21Gx2.2mm	23Gx2.3mm	26Gx1.8mm	28Gx1.8mm	30Gx1.8mm
Color	Orange	Green	Yellow	Pink	Purple



**GT042-400  
Lancing Device**

Material : Plastic. 5 Depth Adjustment  
Material : Plastic. 10 Depth Adjustment  
Material : Plastic. 6 Depth Adjustment  
Individually Packing: Box or Hard Blister Packaging.



**GT041-600  
Surgical Handle**

Size: 3#/12.1cm, 4#/14cm  
Material: Stainless Steel  
Packing: 1pc/aluminium Foil Bag



Size	21G	26G	28G	30G
Color	Green	Yellow	Orange	Purple

**GT042-304  
Safety Lancet**

Mini safety lancet, independent used type.  
Length: 37.99mm  
Width: 6.45mm  
Depth: 1.8mm  
Bleeding amount: 100-200µL



**GT043-301A  
Pressure Activated Blood Lancet I**

Size	21Gx2.2mm	21Gx2.4mm	23Gx1.8mm	26Gx1.8mm	28Gx1.8mm	30Gx1.8mm
Color	Orange	Purple	Green	Yellow	Pink	Light Purple



**GT043-301B  
Pressure Activated Blood Lancet II**



**GT042-303  
Safety Lancet**

Size 18G 2.2mm blade 21G 2.4mm blade 21G 2.4mm 23G 2.2mm 26G 1.8mm 28G 1.8mm 30G 1.6mm  
Color Pink Light Blue Green Blue Yellow Orange Purple

Size	18G 2.2mm Blade	21G 2.4mm Blade	21G 2.4mm	23G 2.2mm	26G 1.8mm	28G 1.8mm	30G 1.6mm
Color	Pink	Light Blue	Green	Blue	Yellow	Orange	Purple

**Disposable Medical Razor**

Carbon steel or stainless steel, single or double blade.  
All razors come with the highest quality stainless steel blades or carbon steel, comfort-coated for smooth shaves.



GT040-200B

GT040-200C



GT040-200A



GT040-300

**GT043-100  
Disposable Medical Razor**

Carbon steel or stainless steel, single or double blade.  
All razors come with the highest quality Stainless Steel blades or carbon steel, Comfort-Coated for smooth shaves.  
Packing: 100pcs/box, 1000pcs/carton, 63x32x21cm

# Surgical Suture

**Features:**

- 1) Suture material: polyglycolic acid (synthetic absorbable sutures), chromic and plain catgut, braided silk, monofilament nylon, monofilament polypropylene, braided polyester, and monofilament stainless steel wire
  - 2) thread 45cm, 60cm, 75cm, 100cm, 125cm, 150cm ect.
  - 3) Thread diameter: 8/0, 7/0, 6/0, 5/0, 4/0, 3/0, 2/0, 1/0, 1, 2, 3. ect
  - 4) Needle shape: 1/2 circle, 3/8 circle, 1/4 circle, 5/8 circle, straight cutting, J-shape
  - 5) Needle end type: rolled end, drilled end, regular-eye end
  - 4) Needle body: taper point, blunt taper point, cuttinh edge, reverse cutting edge, tapercut, micro-point spatula curved
  - 5) Sterilization method: gamma radiation or ethylene oxide (can be used directly without being re-sterilized before use)
- Inner packing: 1 set/sealed polyester and aluminum foil sachet

**Outer packing:**

12 foil sachets/printed paper box or plastic container 50boxes/carton(28X28X34cm)



Thread length:	45cm, 60cm, 75cm, 100cm, 125cm, 150cm etc.
Thread diameter:	8/0, 7/0, 6/0, 5/0, 4/0, 3/0, 2/0, 1/0, 1, 2, 3 etc.
Needle length:	6mm, 8mm, 12mm, 18mm, 22mm, 30mm, 35mm, 40mm, 50mm etc.
Needle curvature:	straight, 1/2 circle, 1/2 circle(double), 1/4 circle, 1/4 circle(double), 3/8 circle, 3/8 circle(double), 5/8 circle, loop round
Cross section:	round bodied, round bodied (heavy), curved cutting, curved cutting (heavy), reverse cutting, reverse cutting (heavy), tapercut, micro-point spatula curved etc.



GT044-100  
Chromic catgut



GT044-200  
Plain catgut



GT044-700  
Polyglycolic Acid



GT044-300  
Silk braided

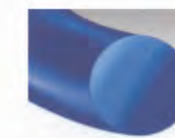

GT044-400  
Nylon monofilament

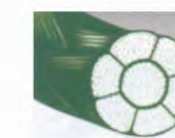





GT044-500  
Polyester braided

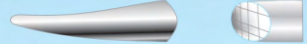
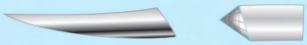

GT044-600  
Polypropylene

## NEEDLE SHAPES

	POINT TYPE	SYMBOL
	taper point	●
	blunt taper point	●
	cutting edge	▲
	reverse cutting edge	▼
	tapercut	⊗
	micro-point spatula curved	◡

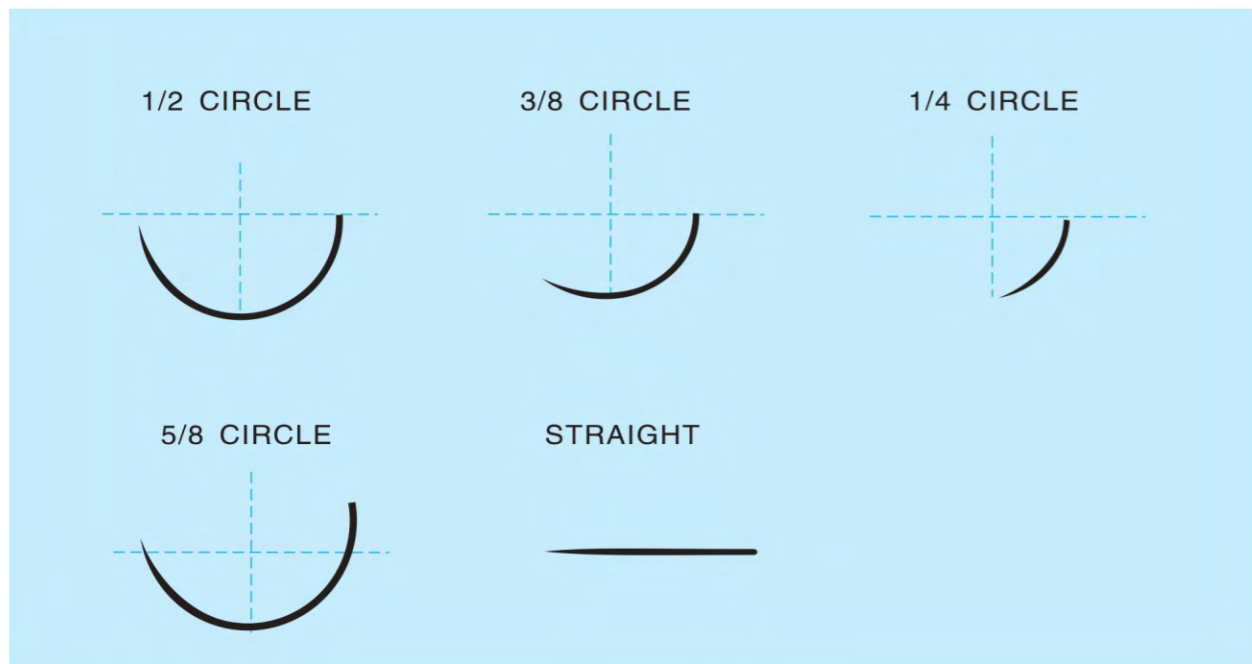

# Cotton Products



[www.medicaltd-china.com](http://www.medicaltd-china.com)



**MEDICA**

Yiwu Medica Import and Export Co., LTD

Add: Office #812, 8th Floor, Jiaheng Apartment, 1543 Chouzhou North Road, Futian Street,

Yiwu City, Jinhua City, Zhejiang Province, China

Tell/WhatsApp: +8615216877512

Email: [info@medicaltd-china.com](mailto:info@medicaltd-china.com)

Web: [www.medicaltd-china.com](http://www.medicaltd-china.com)

## GT065-100

### Gauze Swabs

All pads are folded by machine, 100% cotton ensures the product soft and adherent. Superior absorbency makes the pads perfect for absorbing blood and exudates. In accordance with the customers' requirements, we can produce different kinds of pads, such as folded and unfolded, with X-ray and non X-ray.

The adherent pads are perfect for operations.



#### 40s x 40s/26 x 18 (17th) Folded or Unfolded, with or without X-ray thread

2"x2"-8ply	100/pkg	50/case
2"x2"-12ply	100/pkg	50/case
3"x3"-8ply	100/pkg	40/case
3"x3"-12ply	100/pkg	40/case
4"x4"-8ply	100/pkg	20/case
4"x4"-16ply	100/pkg	20/case
8"x4"-8ply	100/pkg	10/case
8"x4"-24ply	100/pkg	5/case

#### 40s x 40s/20 x 12 Folded or Unfolded, 2'S, sterile packing

2"x2"-8ply	2/pouch	50/box	24/case
2"x2"-12ply	2/pouch	50/box	24/case
3"x3"-8ply	2/pouch	50/box	24/case
3"x3"-12ply	2/pouch	50/box	24/case
4"x4"-8ply	2/pouch	50/box	12/case
4"x4"-12ply	2/pouch	50/box	12/case
4"x4"-16ply	2/pouch	50/box	12/case
8"x4"-8ply	2/pouch	50/box	10/case

#### 40s x 40s/26 x 18 Folded or Unfolded, 5'S Blister packing

5x5cm-8ply	5/pkg	30/box	20/case
7.5x7.5cm-8ply	5/pkg	30/box	15/case
10x10cm-8ply	5/pkg	30/box	10/case
10x10cm-12ply	5/pkg	30/box	8/case

#### 40s x 40s/26 x 18 Folded or Unfolded, 5'S Blister packing

2"x2"-8ply	5/pkg	30/box	20/case
3"x3"-8ply	5/pkg	30/box	15/case
3"x3"-12ply	5/pkg	30/box	5/case
3"x3"-24ply	5/pkg	15/box	20/case
4"x4"-8ply	5/pkg	30/box	10/case
4"x4"-16ply	5/pkg	15/box	20/case
8"x4"-8ply	5/pkg	30/box	10/case
8"x4"-24ply	5/pkg	15/box	4/case

## GT065-200

### Cutting Gauze

Following customers' request of 100% cotton yarn, the cutting gauze is degreased, bleached and cut, and is widely used in beauty, wound dressing, and medical instrument cleaning. Inner up and down with white paper board, outer white paper.

#### 21s x 21s/30x20; 21s x 21s/30x30; 32s x 32s/30x20; 32s x 32s/30x30

10cm x 10cm	1kg	20/case
15cm x 15cm	1kg	20/case
20cm x 20cm	1kg	20/case
25cm x 25cm	1kg	20/case
30cm x 30cm	1kg	20/case
40cm x 40cm	1kg	20/case
60cm x 60cm	1kg	20/case
10cm x 20cm	1kg	20/case
30cm x 40cm	1kg	20/case
30cm x 50cm	1kg	20/case
36cm x 40cm	1kg	20/case



## GT066-100

### Gauze Roll

The gauze is made of 100% cotton fabric, degreased and bleached by advanced way to ensure superior purity and absorbency.

It has two types: X-ray and non X-ray. The quality meets the standards of English Medical Dictionary.

The product has no fluorescence. It is used widely in medical circle and other areas.



#### 40s/30x20, 40s/26x18, 40s/19x15, 40s/20x12

Plain Gauze Roll: 90cm x 500m; 90cm x 1000m; 120cm x 500m; 120cm x 1000m;  
2-ply Gauze Roll White and blue kraft paper: 90cm x 91m; 90cm x 100m;  
120cm x 100m; 4-ply Gauze Roll With X-ray thread White and blue kraft paper per case: 36"x100Y-4ply; 36"x100m-4ply  
4-ply Ellipse Gauze Roll: 36"x100Y-2ply; 36"x100m-2ply

## GT079-100

### O.R. Towel

Constructed of absorbent cotton fiber, our disposable O.R. towels are pre-washed to ensure a virtually lint-free product, and fan folded for handling at ease. Available in blue, white and green, but color-coding can be applied. All the products have different types: Pre-sterile, sterile by steam and by Gamma and non-sterile, some of which can be used in operating rooms such as  $\phi 1''$ ,  $\phi 2''$ ,  $\phi 3''$ ,  $\phi 4''$  towel.



#### 17"x26" Pre-washed

Blue	100/polybag	4/bale
White	100/polybag	4/bale
Green	100/polybag	4/bale

#### 18"x33" Absorbent Reusable Towel

Blue	1/Each	300/case
White	1/Each	300/case
Green	1/Each	300/case
Misty	1/Each	300/case

#### 17"x26" O.R. Towel Blister packing by CSR Paper (W:White, G:Green, B:Blue)

1/pkg	W/G/B	80/case
2/pkg	W/G/B	40/case
4/pkg	W/G/B	20/case
6/pkg	W/G/B	12/case
8/pkg	W/G/B	10/case
10/pkg	W/G/B	8/case
12/pkg	W/G/B	6/case

#### 17"x26" Pre-washed, Hole Towel

Blue with 1" hole	100/polybag	4/bale
White with 2" hole	100/polybag	4/bale
White with 3" hole	100/polybag	4/bale
Blue with 4" hole	100/polybag	4/bale
Green with 4" hole	100/polybag	4/bale

## GT067-100 / GT067-200

### Lap Sponge

Lap sponges are offered to O.R. team for absorbing blood and exudates or for cleaning wounds. It can prevent the wounds from being affected. The sterilization has two types: Steam and "Y". Our laparotomy sponges are sewn and cross-stitched. The producing process is in one million degree purified workshops.



#### 40s x 40s/26 x 18 (17th) Washed, Blue loop, X-ray chip, 5'S

18"x18"-4ply	5/pkg	160/case
8"x36"-4ply	5/pkg	160/case
12"x12"-4ply	5/pkg	280/case
4"x18"-4ply	5/pkg	560/case
8"x36"-4ply	5/pkg	80/case

#### 40s x 40s/26 x 18 (17th) 5'S Packing by CSR Paper Blister Packing

45x45cm-4ply	5/pkg	20/case
30x30cm-4ply	5/pkg	20/case
10x45cm-4ply	5/pkg	280/case

#### 40s x 40s/24 x 20 (17th) Washed, Blue loop, X-ray chip, Iron ring/Plastic ring, 5'S

18"x18"-4ply	5/pkg	160/case
8"x36"-4ply	5/pkg	160/case
12"x12"-4ply	5/pkg	280/case
4"x18"-4ply	5/pkg	560/case

#### 40s x 40s/26 x 18 (17th) Washed, Blue loop, X-ray chip, 5'S, Packing by Wrinkle Paper, Blister Packing with Tray

18"x18"-4ply	5/pkg	20/case
8"x36"-4ply	5/pkg	20/case
12"x12"-4ply	5/pkg	20/case
4"x18"-4ply	5/pkg	20/case

**GT068-100**

**Gauze Bandage**

Through high temperature and pressure degreasing and bleaching, bandage rolls with superior absorbency are made of 100% cotton yarn. The bandage rolls are the necessary products for hospitals. White paper per roll, blue kraft per dozen(12) Edition binding bandage, single packing, blue kraft per dozen(12)



**40s/30x20, 40s/26x18, 40s/19x15, White paper per roll, blue kraft per dozen(12)**

2''x6y	12/Dozen	200/case
3''x6y	12/Dozen	100/case
4''x6y	12/Dozen	100/case
5''x6y	12/Dozen	80/case
6''x6y	12/Dozen	50/case
2''x10m	12/Dozen	100/case
3''x10m	12/Dozen	50/case
4''x10m	12/Dozen	50/case
5''x10m	12/Dozen	25/case
6''x10m	12/Dozen	25/case

**GT070-100**

**Non-woven Swabs**

Non-woven swabs are made from 70% polyethylene and 30% terylene. The pad is designed to wick away fluids and disperse them evenly.

**Bulk Package**

2''x2''-4ply	200/bag	40/case
2''x2''-6ply	200/bag	40/case
3''x3''-4ply	200/bag	20/case
3''x3''-6ply	200/bag	20/case
4''x4''-4ply	200/bag	10/case
4''x4''-6ply	200/bag	10/case

**5'S of Blister Packing**

2''x2''-4ply	5/pkg	25/box	12/case
3''x3''-4ply	5/pkg	25/box	12/case
4''x4''-4ply	5/pkg	25/box	12/case

**GT070-101**

**Non-woven Trach Sponges**

Material: Non-woven

**O/Y Hatch**

2''x2''-4ply	200/bag	40/case
14''x4''-4ply	200/bag	20/case

**O/Y Hatch 2'S of Sterilized Packing**

2''x2''-4ply	2/pouch	25/box	60/case
3''x3''-4ply	2/pouch	25/box	48/case
4''x4''-4ply	2/pouch	25/box	24/case



**GT071-100**

**Trach sponges**

Material: 100% cotton  
Cotton yarn: 40'S X40'S  
Mesh: 19x11, 19x15, 20x12, 24x20, or other mesh per customer's demand.  
Size: 2 " x 2 " , 3 " x 3 " , 4 " x 4 "  
Ply: 4ply, 8ply, 12ply, 16ply etc.  
Edge: Folded or Unfolded  
Color: White  
Sterile or Non-sterile  
Sterilization method: EO or Gamma  
Sterile Packing: 1pc/ two side of paper pouch or one side paper +one side transparent PE film pouch, 2pc/pouch, 5pc/pouch or other packing per customer's demand  
Non-sterile Packing: 100pcs/ paper pack or 100 pcs / polybag;



**GT072-100**

**Absorbent Cotton**

Absorbent cotton is made of 100% cotton fabric, degreased and bleached in advanced ways. The cotton is perfect for beauty, wounds cleaning, alcohol sterilization, and medical instrument cleaning.



**Zig-zag Cotton:**

Rolls are packed by white and blue paper. Package: Plastic bag with thread and a break; Plastic bag with thread and non break. Zig-zag Cotton with Break

**Cotton Roll**

50g	1roll	400/case
100g	1roll	200/case
200g	1roll	100/case
454g	1roll	30/case
500g	1roll	30/case
1000g	1roll	25/case

**Zig-zag Cotton with Break**

50g	1polybag	400/case
100g	1polybag	100/case
200g	1polybag	80/case
250g	1polybag	24/case
500g	1polybag	20/case



**GT074-200**

**Gauze / Non-woven Ball**

100% cotton of our product ensures a superior absorbency. There are two types of this product: with X-ray and non X-ray ball. It is mainly used to absorb blood and exudates during operations and cleaning wounds.

**40s x 40s 30x20 Round Gauze Ball, with and without X-ray thread**

10x10cm	250/polybag	32/case
15x15cm	250/polybag	24/case
20x20cm	250/polybag	16/case
30x30cm	250/polybag	8/case

**40s x 40s/26x18 Round Gauze Ball, Blister Packing**

20x20cm	2/pkg	15/box	60/case
20x20cm	3/pkg	15/box	45/case
20x20cm	5/pkg	15/box	45/case





**GT074-100  
Cotton Ball**

Introduction: Made from 100% natural cotton after cleaning, purifying and bleaching, which is used for cleaning the wound. It can be made into ball.

Grade of Cotton: Natural or Super Absorbent

Weight/piece: 0.3Gram, 0.5Gram, 1.0Gram, 2.0Gram, 3.0Gram, 4.0Gram, 5.0Gram ...etc.

Packing: sealed poly bag packing.

Sterile or Non-sterile

Sterilization method: EO or Gamma



Specification	Packing	Dimension of CTN ( cm )
0.3G/Piece(sterile)	50piece/bag,660bags/ctn	64 x 58 x 46cm
0.3 G/Piece(sterile)	100piece/bag, 330bags/ctn	64 x 58 x 46cm
0.3G/Piece(Non-sterile)	1000piece/bag,33bags/ctn	64 x 58 x 46cm
0.3G/Piece(Non-sterile)	2000piece/bag,16bags/ctn	64 x 58 x 46cm
0.5 G/Piece(sterile)	50piece/bag,400bags/ctn	64 x 58 x 46cm
0.5 G/Piece(sterile)	100piece/bag,200bags/ctn	64 x 58 x 46cm
0.5G/Piece(Non-sterile)	1000piece/bag,20bags/ctn	64 x 58 x 46cm
0.5G/Piece(Non-sterile)	2000piece/bag,10bags/ctn	64 x 58 x 46cm
2 G/Piece(sterile)	50piece/bag,100bags/ctn	64 x 58 x 46cm
2 G/Piece(sterile)	100piece/bag,50bags/ctn	64 x 58 x 46cm
2 G/Piece(Non-sterile)	1000piece/bag, 5bags/ctn	64 x 58 x 46cm
2 G/Piece(Non-sterile)	2000piece/bag,1bags/ctn	46 x 40 x 38cm



**GT075-100  
Eye Pads, Oval Form**

Material: Cotton filled

Cover: Gauze or Non-woven

Type: Self-adhesive or without adhesive

Size: 5cm x 6cm, 8cm x 6cm...etc

Sterile or Non-sterile is available

Packing:

Size: 5cm x 6cm, 1pc/pouch, 50 pouch/ inner box, 20box/ctn, Dim:46 x 42.5 x 20cm;

Size: 8cm x 6cm, 1pc/pouch, 50 pouch/ inner box, 20box/ctn, Dim:57.5 x 46 x 20cm;

Size: 8cm x 6cm, 25pcs/ pack, 40pack/ctn, Dim: 42 x 26 x 30cm;



**GT076-100  
Cosmetic Cotton swabs**

Material: 100% Super Absorbent cotton, and 100% Introduction: Made from 100% Super Absorbent cotton or 100% natural paper fibre, the material is very soft, purifying with High temperature, which is used for cleaning the wound or dressing.

Shape: Round, or Square,

Type: Plain, lattice and flower pattern,

Concavo-convex dot,... and so on.

Size  $\phi$ 5.5cm,  $\phi$ 6.0cm 6cm x 6cm, 7.5cm x 5cm



**GT077-300  
Cotton Swab (plastic Stick)**

Specification: Single Tip For Medical Use

Material of The Stick: PP, PS(can Break It Off)

Diameter of The Plastic Stick: 2.5mm-4.0mm

Length of The Plastic Stick: 75mm-400mm

Diameter of The Cotton Tip: 4-15mm

Length of The Cotton Tip: 15-50mm

CE Approved

# Wound Dressing



[www.medicaltd-china.com](http://www.medicaltd-china.com)



Yiwu Medica Import and Export Co., LTD

Add:Office #812, 8th Floor, Jiaheng Apartment, 1543 Chouzhou North Road, Futian Street, Yiwu City, Jinhua City, Zhejiang Province, China

Tell/WhatsApp: +8615216877512

Email: info@medicaltd-china.com

Web: www.medicaltd-china.com



**GT087-100  
Elastic Crepe Bandage**

Material:Cotton + spandex  
Crepe or Plain  
Color:natural, Flesh or Bleach  
Weight: 75g/m2, 80g/m2,85g/m2, 90g/m2 Etc.  
Width: 2",3",4",5",6"etc.  
Length: 4m, 4.5m, 5m, 6m Etc.  
Sterile or Non-sterile  
Packing: 1roll/poly Bag, 12roll/bag



**GT088-100  
PBT Elastic Bandage**

Material:Polyester  
Color: Bleach  
Weight: 28g/m2, 29g/m2, 30g/m2,60g/m2 Etc.  
Width: 2", 3", 4", 5", 6",Etc.  
Length: 4m, 4.5m, 5m, 6m Etc.  
Sterile or Non-sterile  
Packing: 1roll/poly bag, 12roll/bag



**GT091-101  
Self-adhesive Elastic Bandage**

Material: Cotton With Spandex  
Crepe or Plain  
Color: White, Skin  
Width: 2",3",4",5",6",etc.  
Length: 4m, 4.5m, 5m, 6m Etc.  
Sterile or Non-sterile  
Packing: 1roll/poly Bag, 12roll/box



**GT091-102  
Non-woven Self-adhesive Bandage**

Material: Non-woven PP  
Color: White,blue,green,red,brown,yellow Etc.

Width: 2",3",4",5",6",etc.  
Length: 4m, 4.5m, 5m, 6m Etc.  
Sterile or Non-sterile  
Packing: 1roll/poly Bag, 12roll/box



**GT089-100  
Cotton Crepe Bandage**

Material:100% Cotton  
Natural color, Bleached  
Weight: 75g/m2, 80g/m2,85g/m2, 90g/m2 Etc.  
Width: 2",3",4",5",6",etc.  
Length: 4m, 4.5m, 5m, 6m Etc.  
Sterile or Non-sterile  
Packing: 1roll/poly Bag, 12roll/bag



**GT090-100  
High Elastic Bandage**

Material: Polyester + Rubber string  
Color: Bleach, Natural  
Weight:90g/m2, 105g/m2  
Width: 2",3",4",5",6",etc.  
Length: 4m, 4.5m, 5m, 6m Etc.  
Sterile or Non-sterile  
Packing: 1roll/poly Bag, 12roll/bag



**GT091-103  
Cotton Self-adhesive Bandage**

Material: Cotton  
Color: White,blue,green,red,brown,yellow Etc.

Width: 2",3",4",5",6",etc.  
Length: 4m, 4.5m, 5m, 6m Etc.  
Sterile or Non-sterile  
Packing: 1roll/poly Bag, 12roll/box



**GT092-100  
Plaster Of Paris Bandage**

Material: Cotton With Plaster  
Color: White  
Weight:390g/m2, 400g/m2,410g/m2 Etc.  
Width: 2",3",4",5",6",etc.  
Length: 4m, 4.5m, 5m, 6m Etc.  
Sterile or Non-sterile  
Packing: 1roll/poly Bag, 12roll/box

**GT102-170 Net bandage  
Material:Polyester + Rubber string**

Color: White  
Weight: 120g/m2  
Size: #0.5 0.8cm x 25m, #1 1.7cm x 25m, #2 2cm x 25m,  
#3 2.2cm x 25m, #4 2.6cm x 25m, #5 3cm x 25m,  
#5.5 3.8cm x 25m, #5.8 4.4cm x 25m, #6 5.5cm x 25m,  
#7 6.8cm x 25m, #8 8cm x 25m



**GT172-300  
Tubular Bandage**

Material:100% Cotton, 20m Cotton + 10m Rubber string  
Color: Natural white  
Introduction:Made from 100% natural cotton, which is used for the wound and sport. It can be made into roll.  
Size: 4.5cm x 10m, 6.25cm x 10m, 6.5cm x 10m, 6.75cm x 10m, 7.5cm x 10m,  
8.75cm x 10m, 10cm x 10m, 12cm x 10m, 17.5cm x 10m, 21.5cm x 10m,  
32.5cm x 10m



**GT096-300  
Orthopedic Wool Padding**

Material:100% Cotton or Synthetic Fiber  
Size: 5/7.5/10/15/20/25/30cm x 2.7/3.0/4.0m

**GT096-200**  
**Strip Sports Adhesive**

The strip sports adhesive tape uses cotton cloth serving as a base material and adhesive cement mainly made of zinc oxide and rubber, and the adhesive cement is coated in a shape of strip. When the product is used, firstly clean and dry the skin, tear out the product according to the needed length, and apply it to the needed part. The product has the sports protection effect, but it can't be directly applied to the wounds.

Size: 5 / 7.5 / 10 / 15 / 20cm X 5M



**GT096-400**  
**Muscle Tape**

Material: Elastic fabric  
Color: White, Skin Color, Black, Red, Green, Blue, Yellow, Pink, Multicolour, Etc  
Width: 2.5,5,7.5,10cm  
Length: 4.5,5m  
Packing in Hanging box

**GT082-100**  
**First-Aid bandage**

Cotton filled Size: L, M, S  
Packing: Vacuumize  
Packing: Size: Small, 1pc/ Vacuumize pack, 400 pack/ctn, Dim: 50 x 32 x 36cm  
Size: Medium, 1pc/ Vacuumize pack, 400 pack/ctn, Dim: 50 x 44 x 36cm  
Size: Large, 1pc/ Vacuumize pack, 400 pack/ctn, Dim: 50 x 46 x 43.5cm



**GT083-100 Triangle Bandage**

Material: 100% cotton or Non-woven  
Cotton Yarn: 40 x 34, 50 x 30, 48 x 48 etc.  
Size: 36"x36"x51", 40"x40"x56"  
Non-woven: PP, SMS  
Size: 96x96x135cm  
With or without safety pin Colored: Grey or Bleached  
Packing: 1pc/sealed poly bag, 240bag/ctn  
Dim: 45x38x22cm  
G.W.: 6.5KGS, N.W.: 5.0KGS

**GT096-100**  
**Zinc oxide plaster**

Material: 10% Zinc oxide with 90% hot melt adhesive  
Color: White Or Skin Color  
Serrated/breathable  
Packing: Simple Packing, Cutter, Plastic Can, Tinplate Can



**GT097-100**  
**Non-woven surgical tape**

Material: Non-woven with adhesive  
Color: White, Flesh.  
Packing: Plastic can, Plastic cutter or simple packing.

**GT098-100**  
**PE surgical tape**

Material: Polyethylene with adhesive  
Color: Transparent  
Transparent Micro-hole, Smooth Surface/frosted Face  
Packing: Simple Packing, cutter, plastic Can, Tinplate Can



**GT099-100**  
**Silk surgical tape**

Material: Silk with adhesive,  
Drilled or non-drilled is available  
Line shape or zig shape is available  
Color: White Or Skin Color  
Packing: Simple Packing, cutter, plastic Can, Tinplate Can

**GT102-160  
Fiberglass Casting Tape**

Material: Fiberglass  
 Size: 5cmx360cm, 7.5cmx360cm, 10cmx360cm,  
 12.5cmx360cm, 15cmx360cm etc.  
 Packing: 1pc/ Aluminum Foil Bag 50pcs/box 100box/carton



**GT085-100  
Paraffin Impregnated Gauze Pad**

Material: 100% cotton  
 Product Feature:

- Vaseline gauze is a fine mesh, absorbent gauze impregnated with Vaseline, designed to provide a moist environment for wound, facilitate healing process.  
 Can be used as primary dressing on the wound, when cover a secondary dressing such as gauze swabs to absorb exudate, the vasaline gauze prevents the secondary dressing adhere to wound site.
- Folding edge or non-folding edge available.
- It's anti-sticking to wound.  
 Remove without pain, No blood.
- Blastic packing: 1pc/pack, 2pcs/pack, 5pcs/pack, 10pcs/pack
- Sterile: EO or Gamma
- Note: personalized specifications as possible as customer's request  
 Packing in box: 5x5cm-36 pieces, 10x10cm-10 pieces  
 Packing in roll: 10cmx2.7m, 15cmx2.7m, 20cmx2.7m



**GT102-150 PU adhesive tape**

Material: Polyurethane film  
 Available in line shape or zig shape  
 Color: transparent  
 Size: 5x1000cm, 10x1000cm, 15x1000cm, 20x1000cm etc.  
 Packing: 100rolls/carton, 50rolls/carton

**GT174-100 Ice Bandage**

Ice wrap is a cold bandage which uses a revolutionarily new technique for treating injuiries, muscle pain and strains.  
 This bandage reduces recovery time from injuries by combing both the cooling and compressing process in an easy-to-use way.  
 A specially formulated solution is infused into the elastic bandage thay begins to evaporate upon contacting skin, thereby causes cooling of the applied area. Icewrap reduces swelling and provides sufficient cooling to make it a very effective treatment.

Sizes available:  
 10cm X 3.2m 120rolls/ctn 66 X 33 X 26cm  
 7.5cm X 3.2m 120rolls/ctn 66 X 33 X 26cm  
 10cm X 3.2m 48rolls/ctn 36 X 27 X 42cm  
 7.5cm X 3.2m 80rolls/ctn 36 X 27 X 42cm



**GT100-100  
Wound Adhesive Plaster**

Cotton Pad With/without Medicine  
 Material: Cotton/pe/pu/pvc/mesh/cartoon/spunlace Etc  
 Size: φ 22, φ 25, 40x10mm, 38x38mm, 60x19mm,  
 72x19mm, 76x19mm, 76x38mm, 114x50mm etc.  
 Packing: 50pcs/box or 100pcs/box, 100box/carton



**GT101-100  
Drilled Plaster**

Material: Drilled Zinc oxide with hot melt adhesive.  
 Waterproof or non-water proof is available  
 With drug or without is available Color: White, Flesh.

Width: 2.5cm, 5cm, 7cm, 10cm, 12cm etc. Length: 1m, 5m etc.



**GT101-200  
Capsicum Plaster**

Size: 4cmx6cm, 7cmx10cm, 11cmx17cm, 12cmx18cm Etc  
 Color: White Or Skin Color

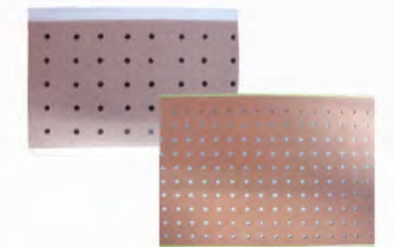

## Hydrocolloid Dressing with Foam

Item Code	Size	Packing
GT 3015	5cm x 5cm	1pc/blister pouch, 20pcs/Mid-box, 10boxes/carton
GT 3016	7.5 x 7.5cm	1pc/blister pouch, 10pcs/Mid-box, 10boxes/carton
GT 3017	10cm x 10cm	1pc/blister pouch, 10pcs/Mid-box, 10boxes/carton
GT 3018	15cm x 15cm	1pc/blister pouch, 10pcs/Mid-box, 10boxes/carton



## GT0010100 Wound Dressing- Cannula Fixation Dressing (U shape)

Non woven fabric material  
Soft, comfortable idea for the cannula fixed dressing  
Without causing allergic or mechanical irritation  
Size: 7.6 x 5.1cm, 6 x 8cm  
Packing: 1pc/blister pouch, 100pcs/Mid-box, 30boxes/carton  
Different sizes, shapes and packages can be produced as per requirements.



## GT00102ZK I.V Cannula Dressing

Size: 6cm x 7cm  
Application: For fixing I.V catheter(basic)  
Packing: 1 pc/blister pouch, 100pcs/box, 40boxes/case



## Wound Dressing ---- Self -adhesive with absorbent pad

Available in strip coating and full coating for the adhesive  
Available in common non woven and waterproof non woven dressing layer.  
High absorbency of the non adhesive absorbent pad  
Without causing allergic or meachanical irritation  
Can be removed without pain.

Item Code	Size	Packing
GT801011	6x3cm	1pc/blister pouch, 100pcs/box, 100boxes/ctn
GT801013	7x3.5cm	1pc/blister pouch, 100pcs/box, 100boxes/ctn
GT801014	7x5cm	1pc/blister pouch, 100pcs/box, 100boxes/ctn
GT801015	7.5x5cm	1pc/blister pouch, 100pcs/box, 100boxes/ctn
GT801016	8x6cm	1pc/blister pouch, 50pcs/box, 24boxes/ctn
GT801017	8x10cm	1pc/blister pouch, 50pcs/box, 24boxes/ctn
GT801018	10x10cm	1pc/blister pouch, 50pcs/box, 24boxes/ctn
GT801019	10x15cm	1pc/blister pouch, 50pcs/box, 24boxes/ctn
GT801020	10x20cm	1pc/blister pouch, 50pcs/box, 24boxes/ctn
GT801021	10x25cm	1pc/blister pouch, 50pcs/box, 18boxes/ctn
GT801022	10x30cm	1pc/blister pouch, 50pcs/box, 12boxes/ctn
GT801023	10x35cm	1pc/blister pouch, 50pcs/box, 12boxes/ctn

## Wound Dressing ---- Waterproof and transparent with absorbent pad

Made of polyurethane film, soft, waterproof and breathable  
Available in right-angle and round angle  
High absorbency of the non adhesive absorbent pad, Good breathability  
Without causing allergic or meachanical irritation  
Can be removed without pain.



## GT8031000 IV Start Kit

- Gauze Swabs 5x5cm 2pcs
- PE Surgical Tape 2.5cmx5m 1roll
- Infusion Plaster 10x12cm 1pc
- Tourniquet Latex Free 1pc
- Povidone-Iodine Pad 1pc
- Alcohol Swab 1pc
- Name Card 1pc

## Made of Polyurethane film, soft, waterproof and breathable Ideal products for catheter, IV Fixation

### GT100101 I.V Cannula Dressing

Size: 4.4cm x 4.4cm  
Application: For fixing I.V. Especially for infants and premature babies  
Packing: 1 pc/blister pouch, 100pcs/box; 40boxes/case

### GT100101U I.V Cannula Dressing

Size: 4.4cm x 4.4cm  
Application: For fixing I.V. Especially for infants and premature babies, and for fixing butterfly and drug kettle catheter  
Packing: 1 pc/blister pouch, 100pcs/box; 40boxes/case

### GT100403V I.V Cannula Dressing

With Non woven underline  
Size: 7cm x 8.5cm  
Application: For fixing arterial and T-prolonged catheter  
Packing: 1 pc/blister pouch, 50pcs/box





### I.V Cannula Dressing GT101106

**Size:** 10cm x 20cm

**Application:** For donor sites and anesthetic catheter fixing

**Packing:** 1 pc/blister pouch, 100pcs/box, 20 boxes/case



### I.V Cannula Dressing GT100608

With silicon absorbent pad

**Size:** 12cm x 9cm

**Application:** for fixing multi-lumen catheter, pulmonary artery catheter, hemodialysis catheter, juguakar, hemodialysis catheter, juguakar, jugular vein and carotid catheter.

**Packing:** 1 pc/blister pouch, 100pcs/box, 20 boxes/case



### GT 102-200

#### I.V Cannula Fixing dressing with Pad

**Size:** 6 cm x 7cm

**Application:** for fixing PICC, and skin with little exudation from pinhole, and used as infants' naval plaster

**Packing:** 1 pc/ blister pouch, 50pcs/box, 40 boxes/case



### GT102-230

#### Lattice Wound Tape

**Material:** Made of 100% cotton, with self-adhesive

Soft, comfortable idea for the cannula fixed dress dressing

Can be removed without pain

**Color:** Skin



### I.V Cannula Dressing GT100704

**Size:** 10cm x 10cm

**Application:** For ulcer, small donor sites, can be used separately or used to fix other non-adhesive absorbent dressing

**Packing:** 1 pc/blister pouch, 100pcs/box, 20 boxes/case



### I.V Cannula Dressing GT100905

**Size:** 10cm x 12cm

**Application:** For fixing CVC(CRP) venae subclavia and segmental enesthetic catheter

**Packing:** 1 pc/blister pouch, 100pcs/box, 20 boxes/case



### GT102-250

#### Absorbent Hemostatic Gauze (Dental Series)

Absorbent Hemostatic Gauze is made from all-natural plant cellulose, ensuring that it's easy on the environment in both production and use

**Effective Hemostat:**

Hemostatic Gauze is one of the most effective ways to accelerate the speed of the body's natural process of hemostasis stopping bleeding from small wounds quickly and thoroughly.

**Size:** 1.1cm x 1.1cm, 4 layers

### I.V Cannula Dressing GT100607V-01

With non woven fabric underline

**Size:** 8.5 x 10.5cm

**Application:** for fixing multi-lumen catheter, pulmonary artery catheter, hemodialysis catheter, juguakar, jugular vein and carotid catheter

**Packing:** 1 pc/blister pouch, 100pcs/box, 20 boxes/case



### I.V Cannula Dressing GT100607V-02

With non woven fabric underline

**Size:** 7 x 8.5cm

**Application:** for fixing multi-lumen catheter, pulmonary artery catheter, hemodialysis catheter, juguakar, jugular vein and carotid catheter

**Packing:** 1 pc/blister pouch, 100pcs/box, 20 boxes/case



### GT096-400

#### Transparent film Rolls

PU adhesive dressing

The PU adhesive dressing is mainly formed by two parts: a base material (PU) and separate paper.

The PU base material is soft, thin and light and mainly used for fixing.

The product is used for the protection of various open injuries.

The product is low in sensitization, excellent in biological compatibility, bacteria-free and high in air permeation, and doesn't irritate or damage the skin nor affect the natural functions of the skin.

**Material**

- ① PET backing
- ② PU Film
- ③ Medical Pressure Sensitive adhesive
- ④ Release paper

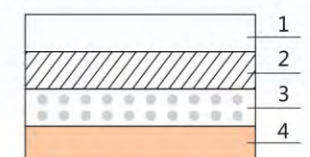

**Size:** 5cm x10m, 10cm x 10m, 15cm x10m



**GT124-200  
Sponge Clean Stick**  
 1# 18cm Flat Stick 20pcs/bag, 40bags/ctn 53 X 52 X 41cm  
 2# 15cm Flat Stick 20pcs/bag, 40bags/ctn 44 X 34 X 42cm  
 3# 10cm Circinal Stick 50pcs/bag, 20bags/ctn 47 X 16.5 X 40cm



**GT086-100  
Alcohol Prep Pad**  
 Material:  
 70% Isopropyl Alcohol(75% Alcohol)  
 Inner Non-woven Size:  
 65x30mm,65x58mm, 80x40mm, 100x60mm,90x90mm,120x110mm,  
 150x120mm, 140x110mm  
 Packing: 1pc/airtight Pack



**GT086-200  
Povidone-iodine Prep Pad**  
 Povidone-iodine Prep Pad  
 Material: 10% Povidone-iodine Solution, equivalent to 1% Available Iodine  
 Inner Non-woven Size:65x30mm,65x58mm,90x90mm,120x110mm  
 Packing: 1pc/aluminum Foil Pouch



**GT086-300  
Adhesive Tape Remover Pad**  
 Contents: Adhesive Tape Remover Pad  
 Non-Woven Size : 65 x 30mm Packet Size : 50 X 50 mm  
 Packing Quality : 100 Pcs / box, 200pcs/box,50boxes/carton53x24x29cm



**GT086-500  
Sting Relief**  
 Sting relief used in wiping the skin area where was stung by mosquito, bee and other insects for relief of pain and itch.  
 30 X 60mm X 2 non-woven pad wrapped in a foil paper sachet sized 50 X 50mm  
 Packing:100pcs/box, 100boxes/ctn  
 Dimension: 54 X 23 X 28cm



**GT086-400  
Povidone-iodine Swabstick**  
 Material:  
 10% Povidone-iodine Solution, equivalent To 1% Available Iodine  
 Size: 70mm(3 Inches), 100mm(4 Inches), 150mm(6 Inches)  
 Packing: 1pc/aluminum Foil Pouch, 2pcs/aluminum Foil Pouch, 3pcs/aluminum Foil Pouch

**GT086-600  
Alcohol Free Cleansing Wipe**  
 Contents: Chlorhexidine Gluconate and Cetrimide  
 Inner Size: 140x110mm, 190x120mm



**GT087-100  
Cleansing Wipe Tube**  
 Contents: Benzalkonium chloride or Alcohol  
 Inner Non-Woven Size :  
 200x130mm, 110wipes  
 200X110mm, 110wipes  
 45X45mm, 110wipes

**GT088-100  
Lemon Glycerine Swab Stick**  
 Material:  
 Impregnated With Solution Of Water, Glycerine Citric Acid Lemon  
 Flavouring, Sodium, Benzoate  
 Size: 70mm(3 Inches), 100mm(4 Inches), 150mm(6 Inches)  
 Packing: 1pc/aluminum Foil Pouch,  
 2pcs/aluminum Foil Pouch,  
 3pcs/aluminum Foil Pouch



**GT088-200  
Alcohol Swab stick**  
 Material: 70% Isopropyl Alcohol(75% Alcohol)  
 Size: 70mm(3 Inches), 100mm(4 Inches), 150mm(6 Inches)  
 Packing: 1pc/aluminum Foil Pouch,  
 2pcs/aluminum Foil Pouch,  
 3pcs/aluminum Foil Pouch

# DENTAL

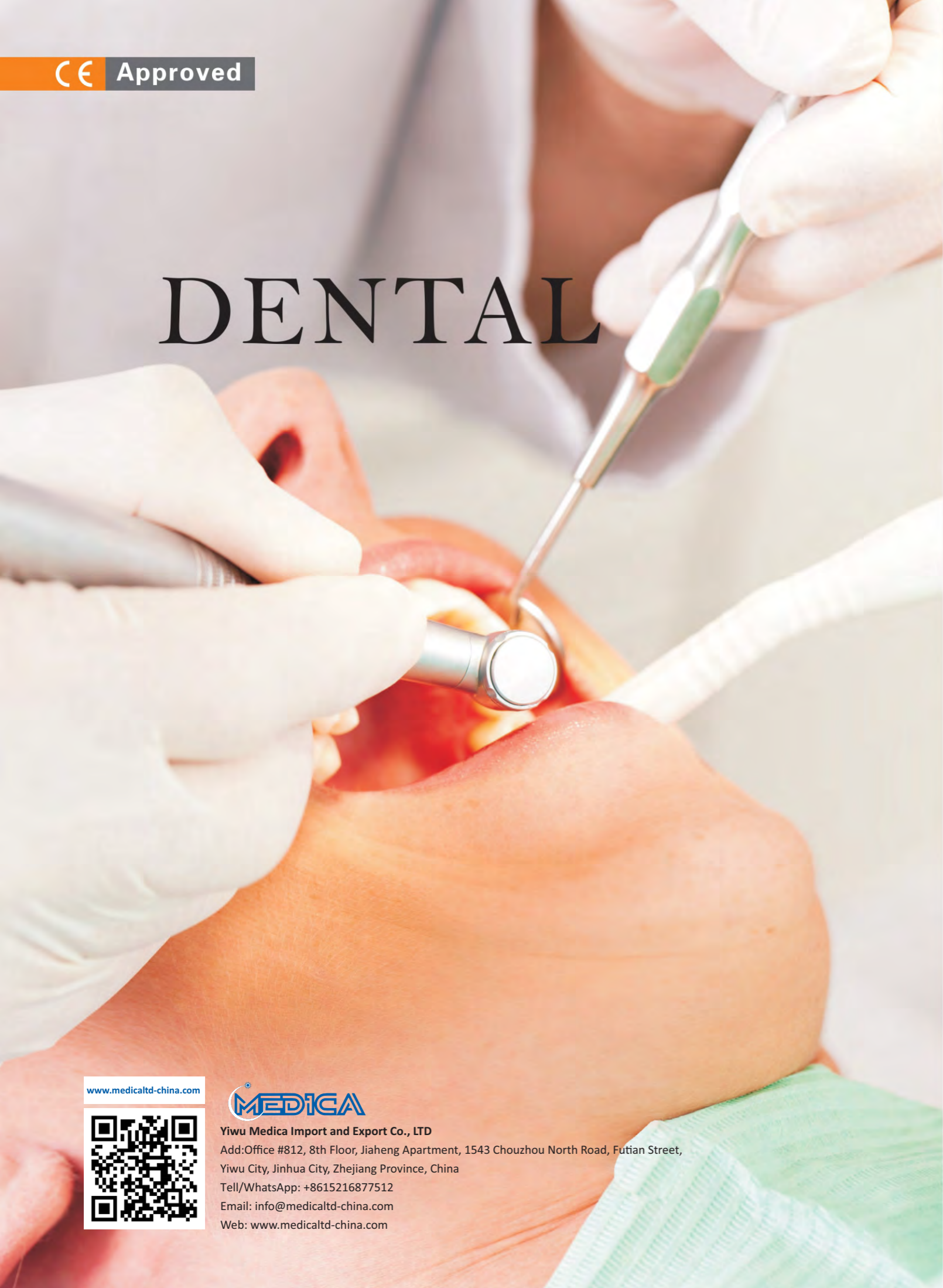

**GT081-100  
Dental Sponges**

Cotton filled  
Cotton Yarn:40's x 40's, 32' x32'  
Mesh:19 x 9, 20 x12 etc.  
Size:2" x 2", 3" x 3", 4" x 4" etc.  
Ply: 8ply etc  
Sterile or non-sterile  
Packing: 100pcs/ pack, 50pack/ctn  
Size: 2" x 2" x 8 ply, 100pcs/pack,  
50 pack/ctn, Dim:: 52 x 42 x 45cm;  
Size: 3" x 3" x 8 ply, 100pcs/pack,  
50 pack/ctn, Dim:: 52 x 50 x 30cm;  
Size: 4" x 4" x 8 ply, 100pcs/pack,  
50 pack/ctn, Dim:: 52 x 52 x 40cm;



**GT080-100  
Dental Cotton Rolls**

Description: 100% Cotton,natural,  
super Absorbent  
**A: 20g/bundle, Dia: 7cm**  
φ 0.8cm X L3.8cm, 56pcs/bundle,  
75bundles/ctn  
φ 1cm X L3.8cm, 41pcs/bundle,  
75bundles/ctn  
φ 1.2cm X L3.8cm, 30pcs/bundle,  
75bundles/ctn  
φ 1.4cm X L3.8cm, 23pcs/bundle,  
75bundles/ctn  
Packing: 36 X 22 X 20cm  
**B: 25g/bundle, Dia: 7.2cm**  
φ 0.8cm X L3.8cm, 60pcs/bundle,  
40bundles/box, 12boxes/ctn  
φ 1cm X L3.8cm, 50pcs/bundle,  
40bundles/box, 12boxes/ctn  
φ 1.2cm X L3.8cm, 38pcs/bundle,  
40bundles/box, 12boxes/ctn  
Packing: 61 X 47 X 43cm



**GT165-100  
Salive Ejector**

Material: PVC  
Length: 15cm  
Packing: 100pcs/bag,  
10bags/ctn, 31.5X24X16cm



**GT094-100 Dental tray**

- Content Of The Set:
1. Plastic Tray
  2. Periodontal Probe With Plastic Handle
  3. Choice Of A Plastic-handle Tweezers (stainless Metal Points)  
Or A Metal-handle Tweezers Or Forceps.
  4. Plastic Stomatoscope, Glass Mirror. Or Pc Mirror, abs Handle.
  5. Dental Bib.
  6. Additional Supplies Such As A Saliva Ejector, Gel Tray,  
Gauze Swabs, Cotton Balls, Dental Brush,  
Dental Cotton , Mask,etc.  
Can Be Assembled To The Individual's Specifications.
  8. Packing:1 Set/plastic Bag,200sets/ctn,61x41x39cm,  
G.W.:12kg N.W.:10kg
  9. Packing:1 Set/blister Bag,480sets/ctn, 61 x 47.5 x 41.5,  
G.W.:13kg N.W.:12kg
  10. Sterilized With E.o.gas.
  11. Expiration Date: 2 Years.



GT094-200A

GT094-200B

**GT094-200A / GT094-200B Dental Bib**

Item: Disposable Bibs  
Material: 2 X 20g Paper Laminated 20g Pe Film  
Size: 33 X 46cm, 33 X 66cm Or 40 X 45cm  
Color: White /green / Pink/blue/green/purple  
Packing: 125pcs/bag,4bags/ctn, 37 X 34.5 X 26.5cm,  
G.W.: 4.5kg, N.W.: 4.2kg







Type: Straigh



Type: Curved

**GT038-201  
Dental Needle**

Size	18G	19G	20G	21G	22G	23G	24G	25G	27G
Color	Pink or Black	Black	Yellow or Black	Green or Black	Grey or Black	Blue	Purple	Blue or Orange	Grey



**GT038-202  
Dental Syringe**  
Material: PP  
Curved Tip, 12ml



**GT038-200  
Dental Needle**  
Size: 27g, 30g  
Description: Sterilized By Gamma  
Packing: 1pc/blister Bag, 100pcs/box, 5000pcs/ctn



**GT038-203  
Beauty Syringe**  
Material : Medical PC  
Luer Lock, 1ml



**GT095-100 Basic Dressing Set 1  
(paper-plastics Compound Bag)**  
100bags/ctn, 47 X 31 X 41cm  
1pc Dressing Tray  
5pcs Cotton Wool Balls 05gm  
5pcs Gauze Swab 7.5cm X 7.5cm-5pcs  
3pcs Dressing Forceps  
1pc Surgical Drape  
1pc Hand Towel  
1pc Limpet Bag  
1pc Sterile Field



**GT095-200 Basic Dressing Set 2(shrink Bag)**  
200bags/ctn, 63x29x34cm  
Item: 1pc Dressing Tray  
8pcs Cotton Wool Balls 0.5gm  
5pcs Gauze Swab 7.5cm X 7.5cm-5pcs  
3pcs Dressing Forceps  
1pc Surgical Drape  
1pc Sterile Field



**GT095-300 Basic Dressing Set 3(blister Bag)**  
Item: 1pc Dressing Tray  
6pcs Gauze Balls  
2pcs Dressing Forceps  
1pc Surgical Drape  
1pc Hand Towel



**GT095-301 Dressing set**  
120bags/ctn, 41 X 34 X 34cm  
1pc Forcep 4#  
1pc Surgical blade  
3pcs Gauze swab 5cmx5cm



**GT095-302 Dressing set**  
40bags/ctn, 38 X 29 X 28cm  
1pc PE+PAPER 33x45cm  
2pc Forcep 4#(blue and green)  
5pcs 40g/m2(D3cm) 0.8G Non-woven ball



**GT095-303 Dressing set**  
40bags/ctn, 38 X 29 X 28cm  
1pc PE+PAPER 33x45cm  
2pc Forcep 4#(blue and green)  
5pcs 20x20cm(28x24mesh) 1.2G Gauze ball  
5pcs Non-woven swab 7.5cmx7.5cm



**GT095-304 Dressing set**  
200bags/ctn, 69 X 42 X 34cm  
2pc Forcep 4#(white and green)  
3pcs Gauze ball 28x24mesh(15x20cm)



**GT095-305 Dressing set**  
40bags/ctn, 39 X 30 X 30cm  
1pc PE+PAPER 32x45cm  
1pc Hemostasia Scissor  
1pc Forcep 4#  
5pcs 20x20cm(28x24mesh) 1.2G Gauze ball  
5pcs Non-woven swab 7.5cmx7.5cm



**GT095-306 Dressing set**  
40bags/ctn, 39 X 30 X 30cm  
1pc PE+PAPER 33x45cm  
1pc Forcep 4#  
5pcs 40g/m2(D3cm) 0.8G Non-woven ball



**GT124-100 Plastic Forceps**  
Size: 10.5cm, 12.5cm, 14cm, 15cm, 19cm



**GT124-200 Hemostasis Pincers**  
Size:length14cm X width7.5cm  
Material:ABS and nylon are available.  
ABS for EO sterilization,  
nylon material for high temperature steam sterilization.  
Color:blue,green,black,red etc. are available.  
Packing:individual sterile blister pack

# FIRST-AID

## GT158-301

Item Name	Specification	Quantity	Units
Adhesive bandage	72 x 19mm	12	pc
Iodine cotton bar	1pc/bag	24	pc
Absorbent adhesive dressing	6 x 7cm	5	pc
Absorbent adhesive dressing	8 x 9cm	5	pc
Absorbent adhesive dressing	10 x 10cm	5	pc
Dressing pad	5 x 5cm	5	pc
Dressing pad	7.5 x 7.5cm	5	pc
Dressing pad	10 x 10cm	4	pc
Scissors		1	pc
Tweezers		1	pc
Alcohol pad	5 x 5cm	4	pc
First aid blanket	204 x 140cm	1	bag
Triangular bandage	90 x 90 x 129cm	1	bag
PBT elastic bandage	10 x 450cm	1	roll
PBT elastic bandage	5x 450cm	1	roll
Adhesive tape	1cm x 10m	1	roll
Safety pin		4	pc
Mouth-to-mouth mask	20 x 20cm	1	pc
Instant ice bag	100g	1	bag
First aid booklet		1	page
First aid instruction		1	page
First aid bag	21 x 14.5 x 6.5cm	1	pc



## GT158-302

Item Name	Specification	Quantity	Units
First aid blanket	204 x 140cm	1	bag
PBT bandage	10 x 450cm	1	roll
PBT bandage	5 x 450cm	2	roll
PVC gloves		1	pair
Alcohol pad	5 x 5cm	6	pc
Scissors		1	pc
Iodine cotton bar	1pc/bag	6	pc
Adhesive bandage	72 x 19mm	6	pc
Absorbent adhesive dressing	6 x 7cm	2	pc
Tweezers		1	pc
Safety pin		4	pc
Adhesive tape	1cm x 10m	1	roll
Dressing pad	5 x 5cm	2	pc
Triangular bandage	90 x 90 x 129cm	1	bag
First aid booklet		1	page
First aid instruction		1	page
First aid bag	15.5 x 11.5 x 6.5cm	1	bag



## GT158-303

Item Name	Specification	Quantity	Units
Self-adhesive elastic bandage	10 x 450cm	1	roll
PBT elastic bandage	10 x 450cm	1	roll
Triangular bandage	90 x 90 x 129cm	2	roll
Iodine cotton bar	1pc/bag	10	pc
Dressing pad	7.5 x 7.5cm	2	pc
Adhesive bandage	72 x 19mm	10	pc
Absorbent adhesive dressing	6 x 7cm	4	pc
PBT first aid bandage	10cm x 2.5m(9.5 x 12cm)	1	roll
Scissors		1	pc
Tweezers		1	pc
First aid booklet		1	pc
First aid instruction		1	pc
First aid bag	15 x 5 x 12cm	1	pc

## GT158-304

Item Name	Specification	Quantity	Units
Mouth-to-mouth mask	20 x 20cm	1	pc
Adhesive tape	1cm x 10m	1	roll
PVC gloves		2	pair
PBT elastic bandage	7.5cm x 4.5m	1	roll
PBT elastic bandage	5cm x 4.5m	1	roll
Triangular bandage	90 x 90 x 129cm	1	pc
Adhesive bandage	72 x 19mm	10	pc
Alcohol pad	5 x 5cm	20	pc
Iodine cotton ball	1pc/bag	5	pc
Safety pin		3	pc
Wound dressing	6 x 7cm	4	pc
First aid blanket	204 x 140cm	1	pc
Burn dressing	40 x 60cm	1	bag
Dressing pad	5 x 5cm	2	pc
Dressing pad	7.5 x 7.5cm	2	pc
Tweezers		1	pc
Scissors		1	pc
First aid booklet		1	page
First aid instruction		1	page
First aid kit	21 x 14 x 7.5cm	1	pc





**GT084-100  
Thermal Accident Blanket**

Material: PET Film  
 Waterproof, use to offset hypothermic reactions, reflective surface provides high visibility, reflects sun and heat for cooling in hot climates, space-age design retains up to 90% of body heat, assists in prevention of post-accident shock and first aid application.  
 Size: 132x210, 140x220cm, 160x 210cm or other size per customer' demand  
 Color: Gold, Silver, Gold + Silver Packing: Each piece in sealed poly bag, 250pcs/ carton;  
 Size: 132cm x 210cm, 250 pcs/ctn, Dim: 41 x 24 x 32cm, G.W.:15.5kgs, N.W.: 13.5kgs;  
 Size: 140cm x 220cm, 250 pcs/ctn, Dim: 41 x 24 x 35cm, G.W.:16.5kgs, N.W.: 14.5kgs;  
 Size: 160cm x 210cm, 250 pcs/ctn, Dim: 42 x 23x 40cm, G.W.:17.0kgs, N.W.: 15.0kgs;

**GT093-100 Splints**

Aluminum plate Macromolecule foam material Nontoxic and nonbenzenoid  
 Free of effect of temperature and climate Type available: Fold, Unfold and Roll  
 Normal size: 5cmx12cm, 5cmx15cm, 7cmx11cm,  
 11cmx44cm, 11cmx91.5cm, 11cmx100cm



**GT167-200  
Underpad**

Size: 17"x24", 23"x36",  
 30"x30", 30"x36", 28"x72"  
 Color: Blue/White/Green, Etc  
 With SAP or without SAP is available.

**GT167-300A  
Adult Diaper**

Size: 800mmx650mm (M)  
 900mmx750mm (L)  
 960mmx800mm (XL)  
 With SAP  
 With or without Wings is available  
 With or without Blue line is available

**GT167-300C  
Child Diaper**

Size: 390mmx280mm (S)  
 450mmx320mm (M)  
 490mmx320mm (L)  
 With SAP  
 With or without Wings is available  
 With or without Blue line is available



**GT167-300A**

**GT167-300C**



**GT167-101 Sterile Delivery Pack**

Non-woven surgical gown-1PC;  
 86x80cm Packing Clothes 2ply(Non-woven and thin film)-1PC;  
 97x73cm Sheet 3ply(Thin film, non-woven and paper pulp)-1PC;  
 97x73cm Triangle Trousers 3ply(Thin film, non-woven and paper pulp)-2PCS;  
 66x43cm Non-woven Cloth 2ply(Thin film and non-woven)-2PCS;  
 66x43cm Non-woven Cloth 1ply-1PC; Umbilical Cord Clamp-1PC;  
 8cm Cotton sticker-2PCS; PE glove-1PAIRS; Latex examination glove-1PAIRS;  
 8x10cm Gauze swab-5PCS; Face mask-1PC; Cap-1PC

# Disposabile Hospital Uniform

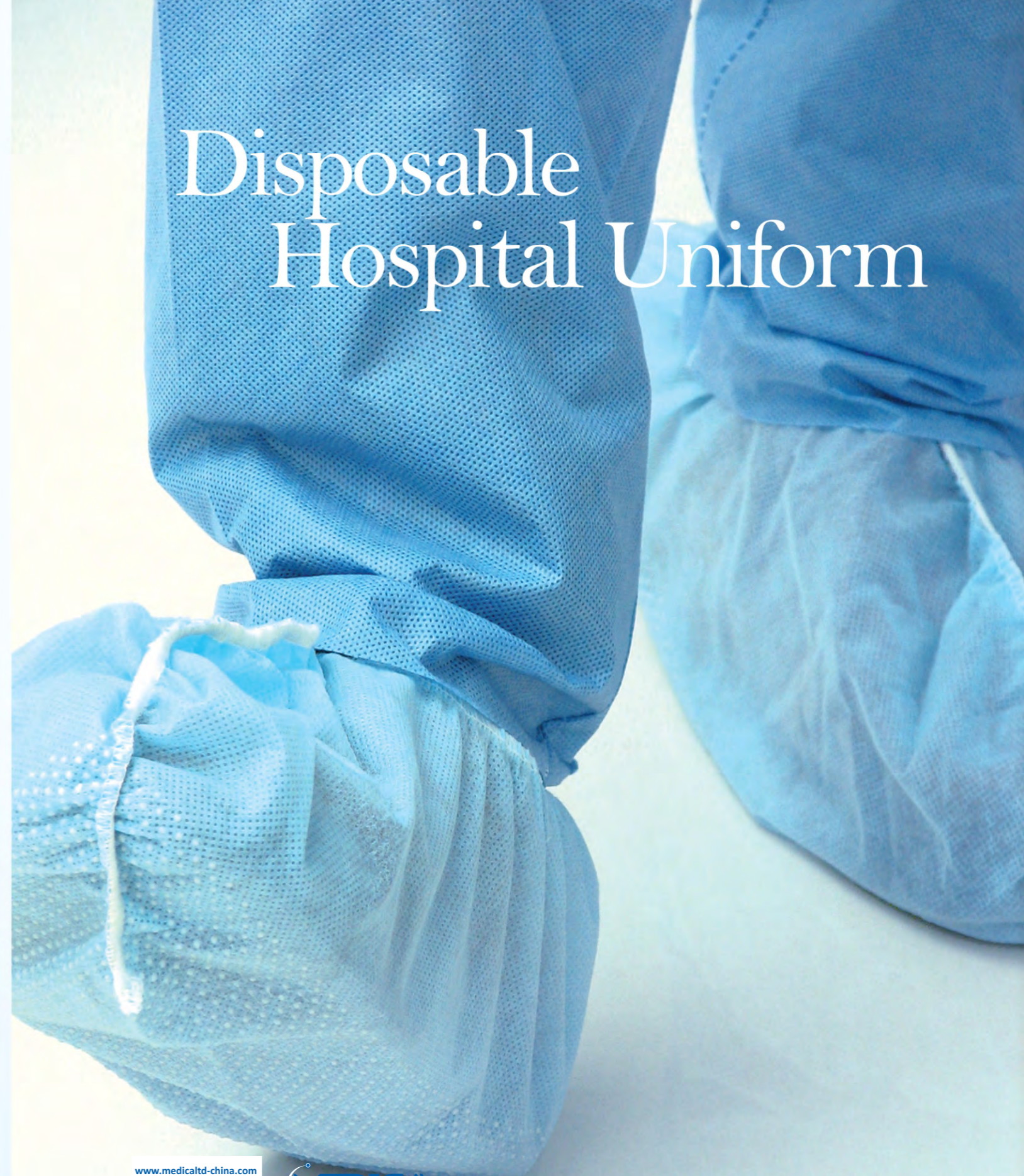

[www.medicaltd-china.com](http://www.medicaltd-china.com)



**Yiwu Medica Import and Export Co., LTD**  
 Add: Office #812, 8th Floor, Jiaheng Apartment, 1543 Chouzhou North Road, Futian Street,  
 Yiwu City, Jinhua City, Zhejiang Province, China  
 Tell/WhatsApp: +8615216877512  
 Email: [info@medicaltd-china.com](mailto:info@medicaltd-china.com)  
 Web: [www.medicaltd-china.com](http://www.medicaltd-china.com)



### GT058-101 Round Nurse Cap

#### Description:

Manufactured From High Quality Non-woven Polypropylene Lightweight, Cool, Comfortable Material – Soft Elastic Headband Suited To Lab, Industry, Hospital And Daily Home Use.

#### Specification:

Non Woven PP Material :  
10g, 12g; 14g; 16g; 18g;  
Available In 18" , 21" or 24" Sizes,  
White, Green or Blue, Pink, Yellow, Red... etc.  
Sterile Method : None or Eo Sterile  
Packing: 100pcs/Poly Bag 10Bags/Carton  
carton size: 240x240x340mm



### GT058-201 Clip Cap

#### Description:

Manufactured From High Quality Non-woven Polypropylene High Quality Material For Increased Durability Convenient Dispenser Lightweight, Cool, Comfortable Material – Soft Elastic Headband , and Comfortable Fold Type Suited To Lab, Industry, Hospital and Daily Home Use.

#### Specification:

Non Woven PP Material: 10g; 12g; 14g; 16g, etc  
Color: White, Green, Blue , Pink ,Red, Yellow  
Size: 20", 21" , 24"  
Type: Single Elastic /Double Elastic  
Sterile Method : None or EO Sterile  
Packing: 100pcs/Poly Bag 10Bags/Carton  
carton size: 530x240x350mm



### GT058-301 Doctor Cap

#### Description:

Manufactured From High Quality, Soft, Non-woven PP Material, High Quality Material For Increased Durability Convenient Dispenser Lightweight, Cool, Comfortable Material – Soft Elastic Headband Suited To Lab, Industry, Hospital and Daily Home Use.

#### Specification:

Non-woven PP Material; 20g, 25g, 30g, 40g  
Color: Green ,Blue  
Type: Tie or Elastic Back  
Size: 61x14cm ; 64x23cm etc.  
Latex Free  
The SMS , Spun Lace Fabric is available  
Packing: 100pcs/ Poly Bag, 10Bags/Carton  
**Size of packing:**  
Export carton: 50x50x30cm or 18x30x30cm  
Gross.Weight: 7.0kgs  
Net.Weight: 6.0kgs



### GT058-401 Net Cap

#### Description:

Made From High Quality, Nylon Net Fabric Material, High Quality Material For Increased Durability Convenient Dispenser Lightweight, Cool, Comfortable Material – Soft Elastic Headband Suited To Lab, Industry, Hospital and Daily Home Use.

#### Specification:

Nylon Net Fabric  
Color: Blue  
Size: 18", 21", 24"  
Packing: 100Pcs/ Box , 10Box/Carton  
**Size of packing:**  
Inner box: 280x260x100mm  
Export carton : 510x290x530mm  
Gross. Weight: 6.0 Kgs  
Net. Weight: 5.0 Kgs



### GT059-200 Nurse Paper Face Mask

#### Description:

Our Most Economical Face Masks ,High Quality Wet-Strength Paper Comfortable Elastic Ear Loops For Easy Donning Product Description

#### Specification:

2 Ply or 1 Ply  
Size: 20x7cm  
Color: White  
Suggested Applications: Polluted Environment, Especially Good For Absorbing and Filtrating The Exhausted Gas From Motor Vehicles.  
Packing: 100 Pcs/Box 100Boxes/Carton



### GT059-101 Non-woven Face Mask

#### Description:

Conforms To American Nelson N95 Test Standards. Mini-Fiber High Electrostatic Filter, Filtration Efficiency of Dust & Powder is over 95%. Repel Continually Contamination of Dangerous Blood and Saliva Continually. Inner Cover Is Well Sweat-Absorbed, While Outer Cover Is Water Resistant. Polypropylene Cloth, Low Breathing Resistance and High Filtration Efficiency.

#### Specification:

Ear-Loop Type: 1ply, 2-Ply or 3 Ply  
Detailed Weight: 1 Ply: 38g/m<sup>2</sup>, 2Ply: 25g/m<sup>2</sup>+18g/m<sup>2</sup>; 3Ply: 25g/m<sup>2</sup>+20g/m<sup>2</sup>+16g/m<sup>2</sup>;  
Size: 18x9cm  
Color: White, Green, Blue, etc.  
Packing: 50Pcs/Box 40Boxes/Carton  
Carton size: 420x390x370mm



### GT059-300 Dust-proof Face Mask

#### Specification:

Conforms To FFP1 & FFP2  
Fiberglass Free, Odorless, Non-irritating To The Skin  
Adjustable Contoured Aluminum Nosepiece Helps To Ensure Proper Fit.  
Low Cost And Easy To Use  
Suggested Applications: Factory, Garden, Process, Maintain, House Cleaning, Motorcycle Riders, Wood, and Any Toxic Free Protection.  
Non-woven PP Material: 16g, 18g, 20g etc  
Color: White, Blue, Dark Blue  
Packing: 50pcs/ Inner Box ; 20Boxes/Carton  
**Size of packing:**  
Inner box: 115x115x125mm  
Export carton: 600x260x250mm  
Gross.Weight: 4.2kgs  
Net.Weight: 3.6kgs



### GT059-120 Face Guard

#### Specification:

Conforms To American Nelson N95 Test Standards. Ear-Loop Type: 3-Ply or 2Ply Non Woven, Polypropylene Cloth, Low Breathing Resistance and High Filtration Efficiency, and PVC Transparent Shield  
Mini-Fiber High Electrostatic Filter, Filtration Efficiency of Dust & Powder is over 95%. Repel Continually Contamination of Dangerous Blood and Saliva Continually. Inner Cover is Well Sweat-Absorbed, While Outer Cover is Water Resistant.  
Packing: 25Pcs/ Inner Box ; 20 Boxes/Carton

#### Size of packing:

Export carton : 540x340x210mm  
Gross.Weight: 4kgs  
Net.Weight: 3kgs



### GT058-501 Surgical Hood

#### Description:

A Disposable Surgical Hood Which Conforms To The Wearer's Head, and is Usable Either with a Traditional Surgical Mask Alone or With Such a Mask In Combination With a Laminar Air Flow Face Plate, Contains Bacterial Fallout From The Wearer's Head and Helps Maintain Sterile Conditions in Hospital Operating Rooms.

#### Specification:

Non Woven PP Material:16g,20g,25g,30g,etc  
Size: 30x124cm

Color: White, Green, Blue  
Packing: 100Pcs/Poly Bag ; 10Bags/Carton

#### Size of packing:

Export carton : 380x300x300mm  
Gross.Weight: 7.5kgs Net.Weight: 6.2kgs



### GT058-502 New Type Dust Proof Face Mask

#### Description:

Conforms To American Nel Son N95 Test Standards. Ear-Loop For Easy Use,160g/180g/200g , Low Breathing Resistance With High Filtration Efficiency. Adjustable Nose Seal, Easy To Fold and Carry. Special 3-Ply Design Respirator Produced From High Filtrable And Electrostatic Material With High Efficient Activated Carbon Cloth For Relief From The Irritating Effects of Nuisance Odor, Acid Gas, Hydrogen Fluoride and Ozone.

#### Suggested Applications:

Polluted Environment, Especially Good For Absorbing and Filtrating The Exhausted Gas From Motor Vehicles.

Packing:50Pcs/ Inner Box ; 20Boxes/Carton

#### Size of packing:

inner box :115x115x128mm  
Size of outer box :600x270x250mm  
Gross.Weight: 5kgs Net.Weight: 4kgs



### GT059-304 N95 Face Mask (with / Without Valve)

#### Specification:

Conforms To International Standarrds: EN149:2001 FFP1 FFP2 CE0194 AS/NZS 1716: 1994 NIOSH N95 Low Breathing Resistance With High Filtration Efficiency. Adopted The Polypropylene Material, Which is Without Any Toxic Chemicals or Stimulant. Adjustable Contoured Aluminum Nosepiece and a Soft Inner Foam Nose Cushion Help To Ensure Proper Fit And Increase Worker Comfort. Easy-Breathing Exhalation Valve With Inner Silicon-Piece Can Facilitate The Air Exchange and Increase Worker Comfort. Special 3-Ply Design Respirator Produced From High Filtrable and Electrostatic Material For Resisting Normal Toxic and Tiny Micro Particle.

#### Suggested Applications:

Chemurgy, Spray-Paint/Printing, Dyeing, Garage, Factories of Electronic Aid and Food, Disinfecting and The Insalubrious Workshops.

Form of Packing: 20Pcs/ Inner Box ; 20Boxes/Carton

#### Size of packing:

Inner box : 120x120x260mm  
Export carton: 620x260x540mm  
Gross.Weight::8kgs Net.Weight:7kgs



### GT059-306 Filtering half masks

flat-folded CE EN 149:2001, protection against solid and fluid particles (FFP1 and FFP2) and protection against toxic particles (FFP3 only), single packed. without valve, FFP1 / with valve, FFP2 / with valve, FFP3  
Package: 20 pcs/box, 400 pcs/carton  
carton size: 57x43x32cm



### GT063-100 Surgeon Gown

#### Specification:

Material: Non Woven PP/PP+PE/SMS  
Color: White/Blue/Yellow/Green.  
Weight: 40/45/50/GSM PP or SMS  
Size: S : 110x154 cm / M : 120x150 cm  
L : 130x155 cm / XL : 140x160 cm / XXL  
Suited to Hospital Use. 10Pcs/Bag 100Pcs/Carton

#### With Ties At Back Of The Neck And Waist

Comfortable Sleeve Tailoring For Maximum Freedom of Movement  
Soft Knit Cuffs For Wrist Comfort  
Secure Sllve Seams For Protection  
Extra Protection Reinforcement on Sleeve & Chest and Full-body on Selected Gowns  
Cloth Like Fabric Breathable, quiet and Supple With Knitted Cuff ,  
Vecro Neck Back Closure, Side Waist Band  
Reinforced Arm And Additional Liner At Front Is Available.  
1 Hand Towel Is Available

Sterile Method : Non Sterile or EO Sterile,  
Packing: 10 Pcs/Poly Bag or 1 Pc/Sterile Bag

#### Sms Surgical Gown

Natural Latex Free,Water Repellent,Protection Against Splatter of Blood  
Breathable,Soft  
100% PP Spunbond + Meltblown(SMS)  
Anti-static is available

#### Spunlace Surgical Gown

Anti-Bacterial,Alcohol-Repellent, Blood-Repellent  
Waterproof Dustproof Breathable, Soft, Comfortable Mobility  
Made From Spunlace Non Woven  
Packing: 1Pcs/Sterile Pack 25Pcs/Carton



with Knitted cuff

with elastic wrist

### GT063-110 Disposable Uniform Isolation Gown

#### Specification:

Material: Offer Economical, Comfortable Reliable and Protection, Non Woven PP/ PP+PE  
Full Length For Maximum Coverage, Latex Free , Sewn Seams Provide Superior Strength, And Extra Length On Waist Ties Allow Gown To Be Easily Secured In Front  
With Ties at Back of The Neck and Waist  
Color: White/Blue/Yellow/Green.  
Weight: 18/ 25/30/40GSM  
or 18/25/30/40GSM PP + 15 PE  
Size: 115 x137cm or 120x140cm etc.

Elastic Wrist or With Knitted Cuff  
10Pcs/Bag, 100Pcs/Carton  
or 1 Pc/sterile Pack ; 50Pcs/Carton  
Sterile Method: EO Sterile  
Suited To Lab, Industry, Hospital and Daily Home Use.  
Form of Packing:  
10 Pcs/Poly Bag or 1Pc/Sterile Packing  
Packing: 10Pcs/Poly Bag 10Bags/Carton  
Carton size: 560x320x350mm



**GT063-150 CPE gown**

This kind of CPE gown Can be used in hospital, laboratory, food industry, any where need protection.

Descriptions:

Can be used in hospital, laboratory, food industry, any where need protection. Prevent and isolate dust, particle, alcohol, blood, bacteria and virus invading. Can be used as a visit coat .Prevent te cross infection in medical treatment at sanitation field. Economical and disposable. Accord with the hygienic standard.

- 1.Material:CPE
  - 2.Characteristics: prevent and isolate dust, particle, alcohol, blood, bacteria and virus invading.
  - 3.Thumb loop wrists prevent sleeves from sliding up when putting gloves on
  - 4.Colour:blue
- Size: 125x200cm, 62g.  
 Package: 1 pc/bag, 100pcs/carton  
 Carton size: 460x200x250mm



**GT063-400 Disposable Scrub Coat**

**Description:**  
 Disposable Scrub Coat are Perfect For any Medical Professional Shopping on a Budget. Available In Several Colors And Made From Quality Non Woven PP Or SMS Material, Disposable Scrub Coat Are Attractive As Well As Affordable. Suited To Hospital And Daily Home Use.

**Specification:**  
 Non Woven PP Or SMS Fabric:48g,55g  
 V Collar Top  
 Elastic Waist Pant  
 Color: Green, Blue  
 Unisex  
 Form Of Packing:1Pcs/ Inner Poly Bag ; 50Boxes/Carton  
**Size of packing:**  
 Export carton:430x340x550mm  
 Gross.Weight:8.5kgs  
 Net.Weight:7.5kgs



**GT166-100 Body bag**  
 10pcs/polybag;  
 20bags/ctn  
 42x34x40/200pcs

**GT063-301 Lab Coat**

**Specification:**  
 Material: Non Woven PP/PE  
 Color: White/Blue/Yellow/Green.  
 Weight: 30/35/40/45GSM ,  
 Size: M:105x130 cm / L:105x135 cm  
 XL:115x140 cm / XXL:115x145 cm  
 With Label Collar/ Knitted Collar and 4 Press Buttons  
 Button Closure or Zipper Closure or Velcro Closure  
 Size: M/L/XL/XXL  
 Suited To Hospital and Daily Home Use.  
 Form of Packing:10Pcs/ Inner Poly Bag ; 100Boxes/Carton  
**Size of packing:**  
 Export carton: 560x320x420mm  
 Gross.Weight:12.5kgs  
 Net.Weight:11.0kgs



**GT063-302 Lab Coat**

**Specification:**  
 Non Woven PP Fabric 40g, 45g  
 71x62cm Short Sleeve Top  
 4 Button Front Closure  
 108x56cm Pant With Elastic Band  
 Color: Blue  
 Keeping The Environment Free of Infection and Disease Is Always a Battle For a Health Professional, Suited To Hospital and Daily Home Use.  
 Form of Packing:1Pcs/ Inner Poly Bag ; 50Boxes/Carton  
**Size of Packing:**  
 Export Carton: 560x350x500mm  
 Gross.Weight:12.5kgs  
 Net.Weight:11.0kgs



**GT063-500 Overall Gown**

**Specification:**  
 With Head Hood & Shoe Cover and Zipper  
 Material: PP/ PP+PE Film / SMS  
 Color: White/Blue/Green/Dark  
 Weight: 35/45/50/60GSM  
**Size:** M/L / XL/XXL at Clients'option  
 S: 164x126 cm / M: 172x130 cm  
 L: 178x134 cm / XL: 182x138 cm  
 XXL: 184x142 cm  
 Suited To Lab, Industrial, Agriculture, Hospital And Daily Home Use.  
 Unique One Piece Design That Cover Whole Body Convenience And Easy To Wear And Off Available In Standard or Pe Coated Coverall, Zipper With Storm Flap, Attached Hood, Boots, Elastic Wrists, Waist & Ankles Are Avaiable Bound Seam Construction  
 Packing: 1Pcs/Poly Bag 50Bags/Carton  
 Carton size: 480x340x410mm



**GT160-100 Non-woven Fabric**  
**Specification:**  
 PP, SMS, Spunlace  
 Kinds of Gram  
 Kinds of Color



**GT061-100 PE Sleeve**

**Specification:**  
 Size 20x40cm,42x22cm,46x22cm  
 Thickness 0.02 mm /0.018mm  
 Made of PE. With Comfortable Elalstic,  
 Water Repellen,  
 Elasticized at Both Ends to Prevent Slippage  
 Fluid Resistant  
 Effective Protection For Wrist and Forearm  
 Clear, White, Blue, Red Colors etc  
 Packing: 100Pcs/Poly Bag 2000Pcs/Carton  
 carton size: 340x230x320mm



**GT062-101 PE Shoe Cover**

**Specification:**  
 Color: Blue or Green  
 Material: PE Fabric:1.6g, 1.8g, 2.0g, 2.1g, 2.5g,  
 Made of PE. With Comfortable Elalstic Opening.  
 Available in Different Thickness and Color  
 Size: 36x15cm, 41x15cm, 40x16cm  
 Thickness:0.016mm, 0.018mm, 0.02mm,  
 0.021mm, 0.025mm at Clients'option  
 Packing: 100Pcs/Poly Bag 5000Pcs/Carton  
 Carton size: 480x320x360mm



**GT064-101 Non-Woven fabrics Bedsheet**

**Description:**  
 Soft touch and harmless to your skin  
 100% biodegradable and environmentally friendly  
 SPEC: light blue, 60x180cm,  
 30gsm other size and specification are also acceptable  
 PACKING: 25pcs/polybag; 4bags/ctn  
 CTN SIZE : 32x25x24 cm /100pcs

**GT060-100 PE Apron**

**Specification:**  
 Made of Polyethylene  
 With Adjustable Tie  
 Available In Different Size and Color  
 Thickness 0.018mm,0.020mm,0.025mm  
 Size : 110x70cm; 135x71cm;160x90cm , etc.  
 Color: White or Blue  
 Package : 100Pcs/Bag,1000Pcs/Carton  
 Packing: 10Pcs/Poly Bag 1000Pcs/Carton  
 Carton size: 360x250x180mm



**GT062-103 Non-woven Shoe Cover**

**Specification:**  
 Color: White, Blue  
 Material: PP Non-woven  
**TYPE A: PP Regular Shoe Covers**  
 Comfortable Elastic Hem,Helps You Keep Your Cool.  
 Easily Worn Under A Sterile Gown. One-size-fits-most Sizing  
 Reduces Your Inventory  
**TYPE B: PP Non-skid Shoe Covers**  
 Non-skid Shoe Covers are Designed For Those Situations  
 Where Wet or Slippery Conditions Exist  
 A Proprietary Plastic Resin Is Applied To The Bottom of  
 The Cover to Improve The Wearers Traciton On The Floor  
 Weight: 30/40/45gsm at Clients'option  
 Size: 36x15cm, 38x18cm , 40x16cm  
 Packing:100Pcs/Bag 1000Pcs/Carton  
**Form of packing:**  
 100pcs/bag 1000pcs/Carton  
 Size of packing: Export carton: 520x280x350mm

**GT062-102 CPE Shoe Cover**

**Specification:**  
 Color: Blue or Green .  
 Material: CPE Fabric: 1.8g, 2.0g, 2.1g, 2.5g,3.0g  
 Made of CPE, Embossed Surface .  
 with Comfortable Elastic Opening.  
 Available In Different Thickness and Color  
 Size: 36x15cm, 41x15cm, 40x16cm  
 thickness:0.02mm, 0.025mm, 0.28mm,0.035mm  
 At Clients' Option  
 Packing: 100Pcs/Poly Bag 5000Pcs/Carton  
 Carton size: 480x320x360mm



**GT064-102 Non-Woven fabrics Bedcover**

**Description:**  
 disposable bed cover made of pp nonwoven fabric,  
 helps you to be clean & hygiene on your travel and regular purpose.  
 SPEC.: 30g,210x90x20cm,  
 other size and specification are also acceptable  
 PACKING: 1pc/roll;10rolls/bag, 2bag/ctn  
 CTN SIZE: 31x14x26cm /20pcs



**GT062-104 High Elastic shoe cover**

Made from High Elastic non-woven Fabric.  
 Size: H23.1 X W17mm  
 Color: White,blue,green,red,brown,yellow Etc.  
 Package: 260 pcs/bag, 6 bags/carton  
 carton size: 64x47x45 cm



**GT168-103 Disposable string**

Non Woven PP, 35 g/m2  
 one size (fits all).  
 Package: 100 pcs/bag, 10 bags/carton  
 carton size: 46x30x29 cm



**GT168-104 Disposable pant**

Non Woven PP, 35 g/m2  
 one size (fits all).  
 Package: 100 pcs/bag, 10 bags/carton  
 carton size: 46x30x33 cm

**GT064-103 Nonwoven Pillow cover**

Disposable pillow covers are used widely in hotels,  
 hospitals, home, and airline and in all travels  
**Specification:**  
 80gsm,50x60cm,with 5cm gusset,  
 other size and specification are also acceptable  
 PACKING: 100pcs/polybag; 1bag/ctn  
 CTN SIZE: 54x32x38 /100pcs



# Homecare



www.medicaltd-china.com



Yiwu Medica Import and Export Co., LTD  
 Add: Office #812, 8th Floor, Jiaheng Apartment, 1543 Chouzhou North Road, Futian Street,  
 Yiwu City, Jinhua City, Zhejiang Province, China  
 Tel/WhatsApp: +8615216877512  
 Email: info@medicaltd-china.com  
 Web: www.medicaltd-china.com



## GT103-100 Hot Water Bag

Size: 750cc/1000cc/1750cc/2000cc  
 /2500cc/3000cc  
 Color: Blue, Green, Red  
 Material: PVC  
 Double Sided Trill, Single Sided Trill  
 Packing: 1pc/1 Pe Bag



## GT103-100 Hot water bag

Size: 750cc/1000cc/1750cc/2000cc/2500cc/3000cc  
 Color: Blue, Green, Red  
 Material: Latex≥30%,  
 Bs Standard: latex≥50%,  
 Double Sided Trill, Single Sided Trill  
 Packing: 1pc/1 Pe Bag



## Gt103-200 Cover For Hot Water Bag

Material: Flannelette/Knit/Furry Etc.  
 Size: 750cc. 1000cc. 1500cc. 1750cc. 2000cc. 2500cc  
 Packing: Individual Opp Bag



## GT104-100 Ice Bag

Size: 6"/9"/11"  
 Packing: PVC Box/PE Bag/Paper Box  
 Can be customized design.



## GT115-001 Instant Ice Pack

280G, PE+PA, 23x14CM  
 160G, PE+PA, 19.5x12CM  
 100G, PE+PA, 15x11CM

### Usage:

Find the liquid bag in the ice bag and make it broken and 3 seconds later it will be frozen. Then shake the bag up and down to make the content fully mixed, and the temperature will be depressed below zero by the ice bag in 2 minutes.

### Purpose:

To control and alleviate the sore and pain caused by strain, bruise, pull and burn, also can rapidly remove the pain and discomfort induced by fever, headache, toothache, mosquito bite.

Freeze and keep fresh vegetable, fruit, beer, beverage and food and so on when no cold source available.

### Precaution:

The ice bag can only be used for external medication. If eye or skin should contact the content, it must be washed by clean water thoroughly. If one eats the content by mistake, he must drink enough water, try his best to vomit it and turn to doctor when necessary.

In order to avoid a too low temperature, it should be better to wrap the ice bag with a towel or cotton cloth to begin with. Those who have something wrong with their circulation system should refer to doctor in advance.

### Characteristic:

This product can refrigerate instantly without cold source and be easily used because of portability.



**GT115-100**

**Instant Hot & Cold Pack**

Material: PVC+Sodium Acetate+Sheet iron  
 Size: 9x9cm 61g; 10x11.5cm 115g; 11.5x11cm 85g;  
 14x13.5cm 185g; 9.5x10.5cm 90g  
 Packing: Individual OPP bag



GT115-100

GT115-101

**GT115-101**

**Instant Hot & Cold Pack**

Material: PVC+Liquid Gel  
 Size: 9.5x8cm 40g; 13x13cm 100g; 10x11cm 60g;  
 17x13cm 200g; 10x10cm 65g  
 Packing: Individual OPP bag

**GT115-105**

**Instant Hot & Cold Pack**

Belt  
 Material: PVC+Round Gel ball+Nylon  
 Size: 27x31; 13.5x33"

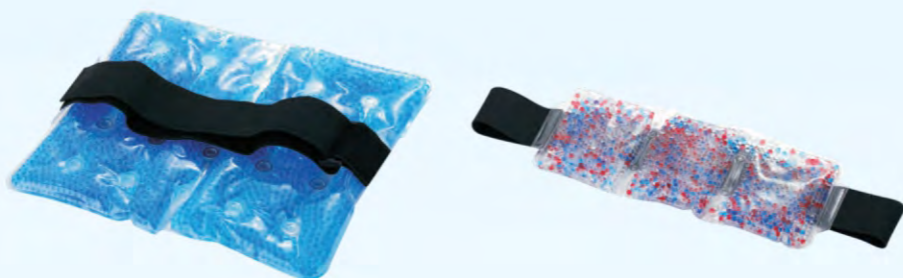

**GT105-100**

**Cold Eye Mask**

Material: Outer bag: PVC  
 Infilling: SAP Ice ball+glycerinum+Distilled water  
 30G, 20.5x5.2CM  
 120G, 77x9CM  
 150G, 68x10CM  
 55g, 24x7.5cm  
 56g, 65x8cm



**GT115-102/104**

**Instant Hot & Cold Pack**

Material: Nylon Taffeta+PVC  
 250G, 23x13cm  
 200G, 20.5x15.5cm



**GT105-100 Air Cushion**

Item: Air Cushion  
 Material: Calcium carbonate + 30% rubber  
 Description:

φ 35cm	1pc/ 1 PE bag	20pcs/ctn	37X37X13cm
φ 40cm	1pc/ 1 PE bag	20pcs/ctn	42X42X15cm
φ 42.5cm	1pc/ 1 PE bag	20pcs/ctn	45X45X16cm
φ 45cm	1pc/ 1 PE bag	20pcs/ctn	47X47X17cm

**GT106-100 Ear Syringe**

Item: Ear Syringe  
 Material: Rubber/PVC  
 Description:

30ml	1pc/ 1 PE bag	600pcs/ctn	37X34X40cm
60ml	1pc/ 1 PE bag	600pcs/ctn	64X34X40cm
90ml	1pc/ 1 PE bag	360pcs/ctn	55X34X40cm



**GT107-100**

**Breast Reliever**

Item: Breast Reliever  
 Material: PVC + 25% rubber  
 Packing: 1pc/1 bag,  
 144pcs/ctn, 63X47X48 cm

**GT108-100**

**Vaginal Syringe**

Material: PVC  
 Size: 90g/150g/220g

**GT109-100**

**Pear Shape Syringe**

Material: PVC  
 Size: 300g

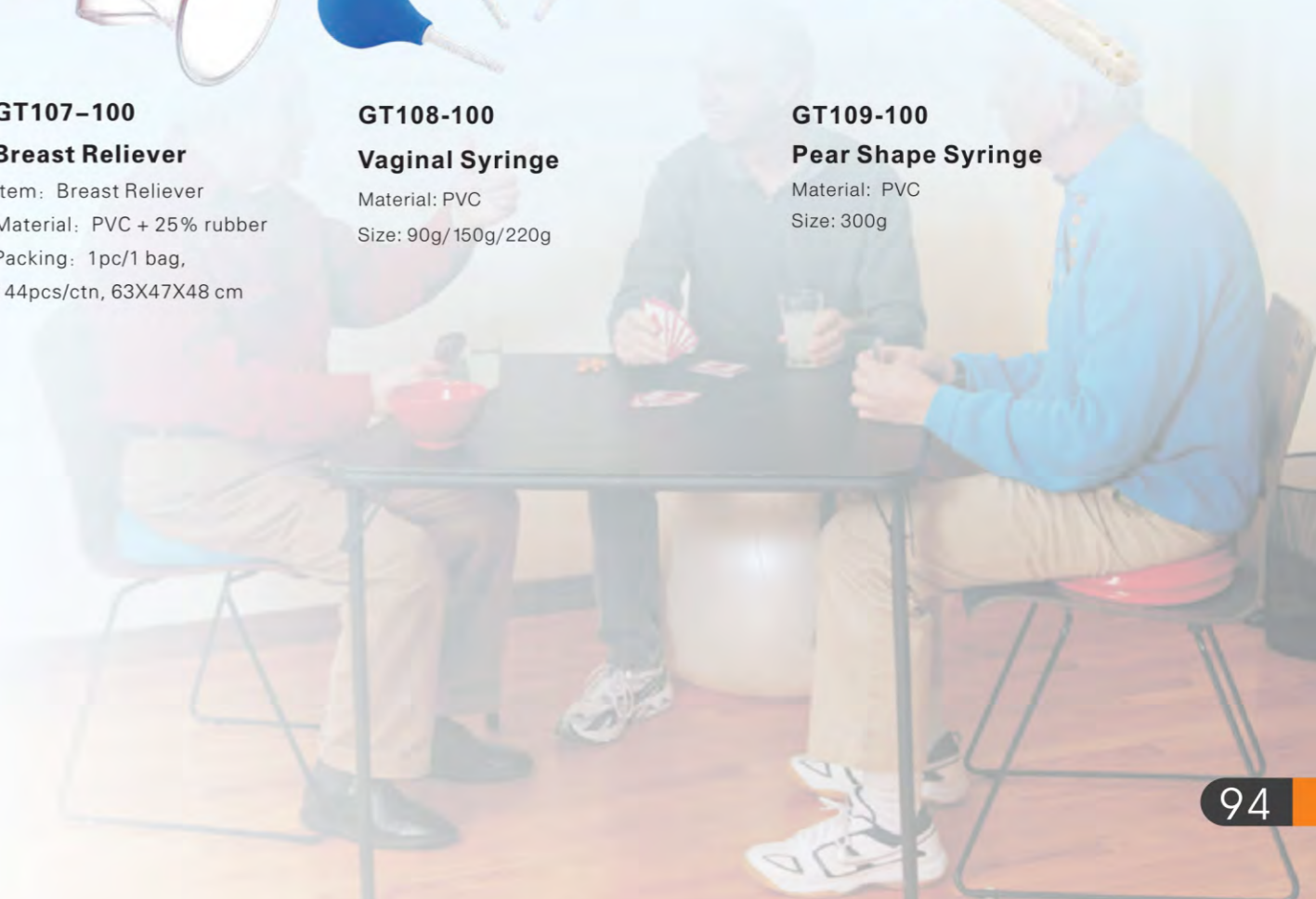

# Plastic Pill Box



**GT164-100**  
**Lover Shape 4 Case Pill Case**  
Material: PP  
Size: 8.3x8.3x2.1cm



**GT164-101**  
**4 Case Pill Case**  
Material: PP  
Size: 12x3x3.2CM



**GT164-102**  
**8 Case Pill Box**  
Material: PP  
Size: 10x7x2cm



**GT164-103**  
**14 Case Pill Box**  
Material: PP  
size: 18.3x9.3x3.3cm



**GT164-104**  
**7 Case Spring Pill Orgnaizer**  
Material: ABS+PP  
Size: 19.7x4.7x2.3cm



**GT164-105**  
**14 Case Detachable**  
Material: PP  
size: 17x7.2x2.5cm



**GT164-106**  
**31 Case Pill Box**  
Material: HIPS+PP  
Size: 28.5x10.5x2.8cm



**GT164-107**  
**28 Case Pill Box**  
Material: ABS+PP+PS  
Size: 21x12.5x2.3cm



**GT164-108**  
**6 Case Pill Box**  
Material: PP  
Size: 9x8x3cm



**GT164-109**  
**The Detachable 7 Case Pill Box**  
Material: PP  
size: 17.5x3.5x2.5cm

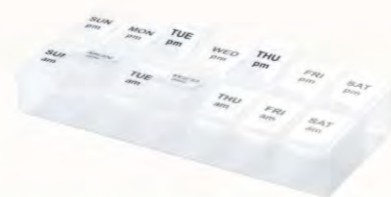

**GT164-110**  
**14 Case Pill Box**  
Material: PP  
Size: 13.5x7x2.5cm



**GT164-111**  
**4 Case Pill Box**  
Material: PP  
Size: 9.5x3.5x2.5cm



**GT164-200**  
**Pill Crusher**  
Material: POM+ PS  
Feature Crush And Store Pills



**GT164-201**  
**Pill Crusher**  
Material ABS+ PS  
Feature Crush And Store Pills  
Colour Blue; Red; White  
Function Easy To Use For Pill  
Storage And Crushing



**GT164-202**  
**Multifunction Medical Pill Crusher**  
Material: ABS+Stainless Steel Blade



**GT164-112**  
**Keyboard Pill Box**  
Material: PP  
size: 23x13x3.2cm



**GT164-113**  
**28Case Pill Box**  
Material: PP  
Size: 20x11x3.8cm



**GT164-114**  
**Oval 28Case Pill Oegnaizer**  
Material: ABS+PP+PS  
size: 9x9x10cm



**GT164-115**  
**28Case Pill Oegnaizer**  
Material: PP +ABS  
size: 9.6x5.9x12cm



**GT164-116**  
**Drawer 28Case Pill Box**  
Material: ABS+PS  
size: 10.5x12.6x4.3cm



**GT164-109**  
**The Detachable 7 Case Pill Box**  
Material: PP  
size: 17.5x3.5x2.5cm

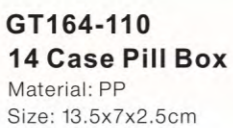

**GT164-110**  
**14 Case Pill Box**  
Material: PP  
Size: 13.5x7x2.5cm

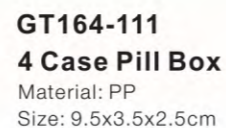

**GT164-111**  
**4 Case Pill Box**  
Material: PP  
Size: 9.5x3.5x2.5cm



**GT164-203**  
**Pill Cutter**  
Material: PS  
Size: 9.5x4.5x3cm



**GT164-204**  
**Multi-function Group of Storage Bottles**  
Material: Tritan+HIPE  
Size: 6x6x20cm

# Sharp Container

**Material:** PP

**Description:** This product is a scleroid plastic container which is used for collecting the needles of the syringes, infusion sets and pointed instruments like blades, scalp vein sets, suture needle, small glass products, etc. This product is for single use and the medical waste put in it is not allowed to be taken out and must be recycled by the waste disposable unit of the hospital, and then safely and completely burned within 48 hours. The product has the characteristics of non-toxic, safe, cast-resistant, and non-leaky.



**GT163-101**

Capacity(L)	Pcs/ctn	Carton Size(cm)
4.0	24	53x42x45



**GT163-102**

Capacity(L)	Pcs/ctn	Carton Size(cm)
3.0	30	47x32x45



**GT163-107**

Capacity(L)	Pcs/ctn	Carton Size(cm)
1.5	60	38x33x48



**GT163-108**

Capacity(L)	Pcs/ctn	Carton Size(cm)
0.8	90	38x38x39.5

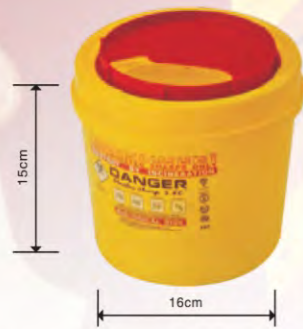

**GT163-103**

Capacity(L)	Pcs/ctn	Carton Size(cm)
3L	30	36x36x37



**GT163-104**

Capacity(L)	Pcs/ctn	Carton Size(cm)
2.0	36	45x30x34



**GT163-109**

Capacity(L)	Pcs/ctn	Carton Size(cm)
1.0	100	47x36x57



**GT163-112**

Capacity(L)	Pcs/ctn	Carton Size(cm)
0.7	100	56x24x43



**GT163-105**

Capacity(L)	Pcs/ctn	Carton Size(cm)
2.0	40	58x29x29



**GT163-106**

Capacity(L)	Pcs/ctn	Carton Size(cm)
3.0	54	47x50x40



**GT163-113**

Capacity(L)	Pcs/ctn	Carton Size(cm)
4.6	20	58x56x28



**GT163-114**

Capacity(L)	Pcs/ctn	Carton Size(cm)
2.0	30	41x34x34

# Sharp Container

**Material:** PP

**Description:** This product is a scleroid plastic container which is used for collecting the needles of the syringes, infusion sets and pointed instruments like blades, scalp vein sets, suture needle, small glass products, etc. This product is for single use and the medical waste put in it is not allowed to be taken out and must be recycled by the waste disposable unit of the hospital, and then safely and completely burned within 48 hours. The product has the characteristics of non-toxic, safe, cast-resistant, and non-leaky.



**GT163-115**

Capacity(L)	Pcs/ctn	Carton Size(cm)
3.0	30	41x34x31.5



**GT163-116**

Capacity(L)	Pcs/ctn	Carton Size(cm)
6.0	24	51x42x34.5



**GT163-120**

Capacity(L)	Pcs/ctn	Carton Size(cm)
8.0	24	44x38x44



**GT163-121 Waste Bag**

Color: Red/Yellow/Black  
 Material: HDPE/LDPE, virgin or recycled  
 Thickness: 40-150 microns per side  
 Packaging: Roll packed, or loosed packed  
 Primary packaging: labels, polybags  
 Secondary packaging: Corrugated cardboard outer cartons, or PP woven bags  
 Type: Open with adhesive tape, 61x61cm, 61x76cm, 61x80cm, 96.5x120cm  
 Plain top without adhesive tape, 42x48+9cm, 19x36+5.5cm



**GT163-117**

Capacity(L)	Pcs/ctn	Carton Size(cm)
5.0	24	51x42x25.5



**GT163-118**

Capacity(L)	Pcs/ctn	Carton Size(cm)
23.0	20	48x39x65



**GT163-122 Specimen Bag**

Material: VIRGIN LDPE  
 Regular Size: 5.5"x6.5", 6"x9", 10"x10", or customized sizes  
 Thickness: 40-100micron per side  
 Advantages: 1.Superior quality and competitive price, waterproof and recyclable material.  
 2.It is environmental protection and excellent quality  
 3.very tough, Good stretchability, Flexibility.  
 4.Timely delivery.  
 5.Each inquiry will be consulted carefully.  
 6. Easy to open and take.  
 Packaging: By normal corrugated cardboard box, about the detail's as customize.  
 Usually 100pcs/bag,10bags/ctn or 20bags/ctn



**GT163-119**

Capacity(L)	Pcs/ctn	Carton Size(cm)
10.0 (A)	12	52x25x73
10.0 (B)	24	51x42x54



**GT163-110 Paper Safety Box**

75pcs/carton,  
 62x30x258.5cm,  
 20/18.5kgs



**GT163-111**

Needle Destroyer without blade 11x9.5cm  
 Needle Destroyer with blade 11x9.5cm

# Rapid Testing Series



Product	Format	Specimen	Packing
HCG	Strip(2.0/2.5/3.0mm)	Urine	100T/BOX
HCG	Device	Urine	25T/BOX
HCG	Midstream	Urine	20T/BOX
LH	Strip	Urine	100T/BOX
LH	Device	Urine	25T/BOX
LH	Midstream	Urine	20T/BOX
HIV 1/2	Strip	Serum/Plasma	100T/BOX
HIV 1/2	Device	Serum/Plasma	25T/BOX
HIV 1/2	Device	WB/Serum/Plasma	25T/BOX
Syphilis	Strip	Serum/Plasma	100T/BOX
Syphilis	Device	Serum/Plasma	25T/BOX
Syphilis	Device	WB/Serum/Plasma	25T/BOX
HAV IgM	Device	Serum/Plasma	25T/BOX
HBsAG	Strip	Serum/Plasma	100T/BOX
HBsAG	Device	Serum/Plasma	25T/BOX
HBsAG	Device	WB/Serum/Plasma	25T/BOX
HCV	Strip	Serum/Plasma	100T/BOX
HCV	Device	Serum/Plasma	25T/BOX
HCV	Device	WB/Serum/Plasma	25T/BOX
Typhoid IgG/IgM	Device	Serum/Plasma	25T/BOX
TOXO IgG/IgM	Device	Serum/Plasma	25T/BOX
Malaria pf/pv	Device	Whole Blood	25T/BOX
Malaria pf/pan	Device	Whole Blood	25T/BOX
Malaria pf	Device	Whole Blood	25T/BOX
Flu A&B	Strip	Nasopharyngeal swab	20T/BOX
Dengue(IgG/IgM)	Device	Whole Blood	25T/BOX
TB	Strip	Serum/Plasma	100T/BOX
TB	Device	Serum/Plasma	25T/BOX
TB	Device	WB/Serum/Plasma	25T/BOX
M.P(IgM)	Device	Serum/Plasma	25T/BOX
H.P Antigen	Device	Feces	25T/BOX
H.P Antibody	Device	Serum/Plasma	25T/BOX
Chlamydia	Device	Swab/Urine	20T/BOX
AFP	Strip	Serum/Plasma	100T/BOX
AFP	Device	Serum/Plasma	25T/BOX
FOB	Strip	Feces	100T/BOX
FOB	Device	Feces	25T/BOX
PSA	Strip	Serum/Plasma	100T/BOX
PSA	Device	Serum/Plasma	25T/BOX
Troponin I	Device	WB/Serum/Plasma	25T/BOX

# Urinalysis Reagent Strips



Name	Specifications	Units	Packaging specifications	Application Analyzer	Test items
Urinalysis Reagent Strips	1 item	bottle	300 bottles / Box	visual	glucose
Urinalysis Reagent Strips	2 items	bottle	300 bottles / Box	visual	protein glucose;glucose ketone, pH protein;pH glucose
Urinalysis Reagent Strips	3 items	bottle	300 bottles / Box	visual	pH,glucose,protein
Urinalysis Reagent Strips	4 items	bottle	300 bottles / Box	visual	pH ,glucose,protein,occult blood
Urinalysis Reagent Strips	8A	bottle	40 bottles / Box	MA-4210,URITEST-200	urobilinogen, bilirubin, ketone, occult blood, protein, glucose, pH , nitrite
Urinalysis Reagent Strips	8N	bottle	40 bottles / Box	visual	urobilinogen, occult blood,bilirubin, ketone, glucose, protein, pH , nitrite
Urinalysis Reagent Strips	10A	bottle	40 bottles / Box	CLINITEK ANALYZER	leukocytes, nitrite ,urobilinogen, protein, pH, occult blood, specific gravity, ketone,bilirubin, glucose
Urinalysis Reagent Strips	10U	bottle	40 bottles / Box	URITEST-100/200/300	leukocytes, ketone, urobilinogen, bilirubin, specific gravity, occult blood, protein, glucose ,nitrite , Ph
Urinalysis Reagent Strips	11U	bottle	40 bottles / Box	URITEST-100/200/300	pH, nitrite,glucose,ascorbic acid, specific gravity, occult blood, protein,bilirubin, urobilinogen ,ketone, leukocytes
Urinalysis Reagent Strips	11H	bottle	40 bottles / Box	HY-100	urobilinogen , occult blood, bilirubin, ketone, leukocytes, glucose, protein, pH, nitrite, specific gravity, ascorbic acid

Name	specifications	Units	Packaging specifications	Application Analyzer	Test items
Urinalysis Reagent Strips	11D	bottle	40 bottles / Box	MAC-120,YX-200,etc	leukocytes, nitrite ,urobilinogen, protein, pH, occult blood, specific gravity, ascorbic acid, ketone,bilirubin, glucose
Urinalysis Reagent Strips	11T	bottle	40 bottles / Box	MA-4280	ascorbic acid, leukocytes, occult blood, urobilinogen, bilirubin, , pH , specific gravity,ketone protein, nitrite ,glucose
Urinalysis Reagent Strips	10B	bottle	40 bottles / Box	BM-200	glucose , protein,urobilinogen, bilirubin, ketone, nitrite, occult blood,leukocytes, pH,specific gravity
Urinalysis Reagent Strips	11A	bottle	40 bottles / Box	HY-100,HL3460B	leukocytes, urobilinogen, occult blood, bilirubin,ketone, glucose, protein, pH , nitrite , specific gravity,ascorbic acid,
Urine Analyzer	HY-100	piece	1 piece/box		

# Vaginal Speculum



**GT159-200**

**Vaginal Speculum Pack**

Contents: Vaginal Speculum(All types available)  
Wrapping Cloth(Blue PE coated non-woven)  
Examination Gloves(S/M/L)  
Optional: Microslide, Cervical Rambrush  
(Models available below)



**GT159-100** Disposable Vaginal Speculum with side screw  
Size: L, M, S



**GT159-101** French type 1 Disposable Vaginal Speculum  
Size: L, M, S, XS, XXS



**GT159-103** Disposable Vaginal Speculum with middle screw  
Size: L, L/ M, M, S, XS



**GT159-104** Disposable Vaginal Speculum Rack Type  
Size: L, M, S



**GT159-106** American type Disposable Vaginal Speculum  
Size: L, M, S



**GT159-104** Spanish Type Disposable Vaginal Speculum  
Size: L, M, S



**GT159-105** Disposable Vaginal Speculum With Smoke Extractor Type  
Size: L, M, S



**GT159-107** Handle Light Used with French Type Vaginal Speculum



**GT159-108** Proctoscope  
Type: with light; without light  
Size: L, M, S



**GT004-136 Thermometer Cover**

Material: PE  
Description: Insert,twist,pull apart or peel back covers  
Packing: 200pcs/box, 150box/carton  
Carton Dimension: 38x32x32cm



**GT085-120 Cooling Gel Patch**

For instant colling sensation soothes fever discomfort  
• Produce fever quickly-Easy to use  
• Gentle to the skin  
• Safe to use with medications  
• Contain non-drug  
• Soothes fever instantly  
• Strong adhesive power  
• 10 hours cooling effect

**Use Instructions:**

Pull off the transparent film and apply aikido gel surface to the effeled area.  
To enhance the cooling effect, place aikido gel in a refrigerator before use, don't place aikido gel in freezer. Aikido gel may be cut to the required size using a pair of scissors



**GT078-100 Surgical Hand Brush**



**GT078-200 Iodine Brush**

Detail Description:  
With liquid  
Povidone-Iodine 5%  
Povidone-Iodine 9%  
Povidone-Iodine 10%  
Isopropyl Alcohol 7%  
Parachlormetaxlyenol 4%  
Parachlormetaxlyenol 3.3%  
Chlorhexidine Digluconate 4%  
Packing: 1/mold bag, 20 bags/bx, 10 bx/ctn



**GT004-137 Ear Thermometer Probe Cover**



**GT112-200 Umbilical Cord Clamp clipper**

Material Pom+ Stainless Steel Blade  
Feature Disposable Medical Use  
Colour: White, Green, Blue  
Function: To Cut Off The Umbilical Cord Clamp When A Woman Giving Birth To A Baby.



**GT112-300 Umbilical Cord Cutter**



**GT112-100 Umbilical Cord Clamp**

Size: 5.0 /5.5/ 6.0 cm  
Material: ABS/PP/PE  
Color: Bule, White, Pink



**GT114-400 Amniotomy Hook**

Material: ABS  
Type: Straight, Curved.



**GT114-100: I.D.Bracelet**

Usage: Record Important Identification Information of A Patient,Tie On Patient's Wrist, 24-hour Close Identification Can Effectively Ensure That Any Time Quickly And Accurately Identify Patients.  
Material:PVC  
Color:Blue,Pink,White,Other Color By Optional  
Model:Adhesive,Write-on,Insert-card, Infant,Adult,Adult&Infant

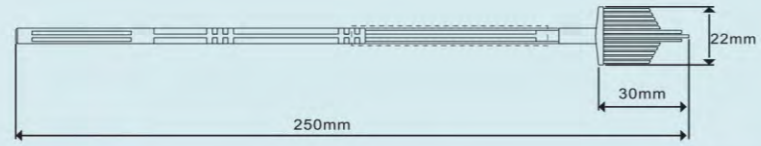

**A**

Number	Model	Description	Packaging	Quantity
GT159-0801	A-1	Push tube, pink brush, individually packaged, EO sterile.	20x100PCS/ carton	>2000PCS
GT159-0802	A-2	No Push tube, pink brush, individually packaged, EO sterile.	20x100PCS/ carton	>2000PCS



**B**

Number	Model	Description	Packaging	Quantity
GT159-0803	B-1	Push tube, blue brush, individually packaged, EO sterile.	20x100PCS/ carton	>2000PCS
GT159-0804	B-2	NO Push tube, blue brush, individually packaged, EO sterile.	20x100PCS/ carton	>2000PCS



**C-1**

Number	Model	Description	Packaging	Quantity
GT159-0805	C-1	Blue brush bar, individually packaged, EO sterile.	20x100PCS/ carton	>2000PCS



**C-2**

Number	Model	Description	Packaging	Quantity
GT159-0807	C-2	Blue brush bar, individually packaged, EO sterile.	20x100PCS/ carton	>2000PCS



**D-1**

Number	Model	Description	Packaging	Quantity
GT159-0820	D-1	Fluffy head, blue brush bar, individually packaged, EO sterile.	20x100PCS/ carton	>2000PCS



**E**

Number	Model	Description	Packaging	Quantity
GT159-0821	E	Fluffy head, blue Push bar, individually packaged, EO sterile.	20x100PCS/ carton	>2000PCS

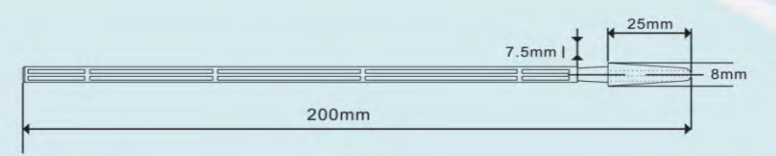

**G**

Number	Model	Description	Packaging	Quantity
GT159-0822	G	Fluffy head, blue brush bar, individually packaged, EO sterile.	20x100PCS/ carton	>2000PCS

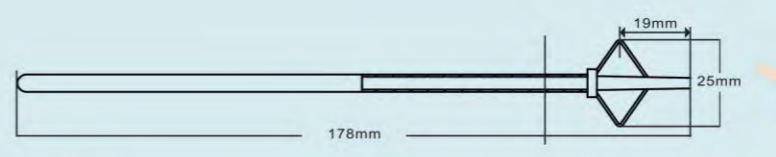

**D-2**

Number	Model	Description	Packaging	Quantity
GT159-0823	D-2	Fluffy head, blue brush bar, individually packaged, EO sterile.	20x100PCS/ carton	>2000PCS

## Disposable Cervical Brush

GT159-0800

Disposable Sampling Swab:

Used for Gynaecology, Andrology, and ENT, Etc.

Extracting epidermal cell by the brush at top.

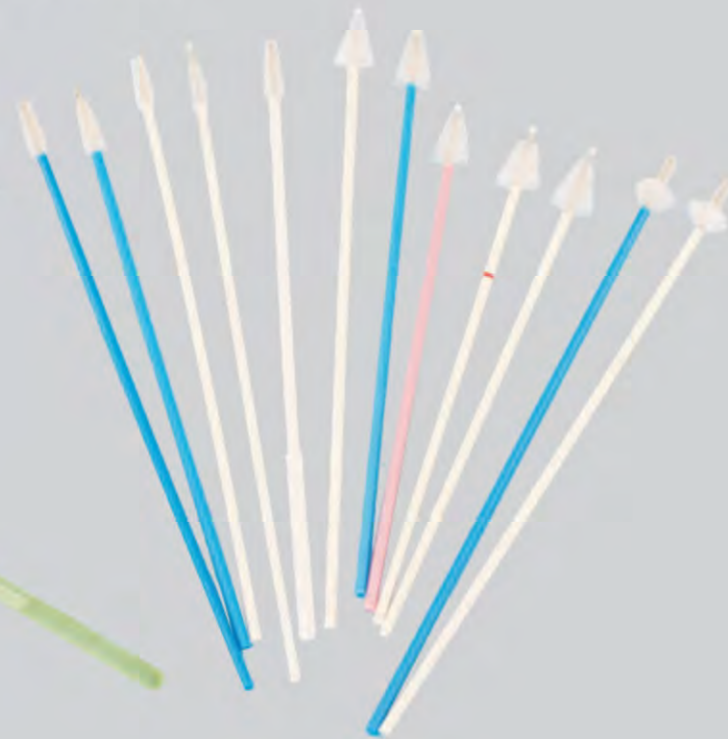

Number	Model	Description	Packaging	Quantity
GT159-0824	I	Two joints, white, FlockKing, individually packaged, EO sterile.	20x100PCS/ carton	>2000PCS
GT159-0825	J	White, small head, FlockKing, individually packaged, EO sterile.	20x100PCS/ carton	>2000PCS
GT159-0826	K-1	White big head, Flocking individually packaged, EO sterile.	20x100PCS/ carton	>2000PCS
GT159-0827	M	White, brush bar with handle, Flocking, individually packaged, EO sterile.	20x100PCS/ carton	>2000PCS

## Disposable Endometrial Suction Cannula

Number	Model	Description	Packaging	Quantity
GT159-0832	Z-2	Four holes head ,individually packaged,EO sterile.	20x100PCS/ carton	>2000PCS
GT159-0833	Z-3	Three holes head ,individually packaged,EO sterile.	20x100PCS/ carton	>2000PCS

## Other Disposable Supplies

### Disposable Sampling Spoon

Number	Model	Description	Packaging	Quantity
GT159-0704-1	A	Thickness 4mm,Weight 3g,Individually packaged,EO sterile.	2000pcs/ carton	>2000pcs
GT159-0704-2	B	Thickness 5mm,Weight 5g,Individually packaged,EO sterile.	2000pcs/ carton	>2000pcs

### Disposable Cervical Smear A

Number	Model	Description	Packaging	Quantity
GT159-0701-1	A-1	Individually packaged,EO sterile.	2000pcs/ carton	>2000pcs
	A-2	Clear Individually packaged,EO sterile.	2000pcs/ carton	>2000pcs

### Disposable Cervical Smear B

Number	Model	Description	Packaging	Quantity
GT159-0702	B	Clear,Individually packaged,EO sterile.	2000pcs/ carton	>2000pcs

### Disposable Cervical Smear C

Number	Model	Description	Packaging	Quantity
GT159-0703-1	C-1	Individually packaged,EO sterile.	2000pcs/ carton	>2000pcs
GT159-0703-2	C-2	Individually packaged,EO sterile.	2000pcs/ carton	>2000pcs



# ECG Paper



- Single-lead ECG Paper
- 3-lead ECG Paper
- 6-lead ECG Paper
- 12-lead ECG Paper

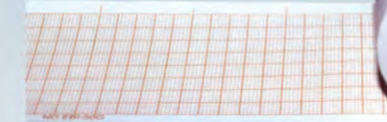

GT148-101  
ECG Paper

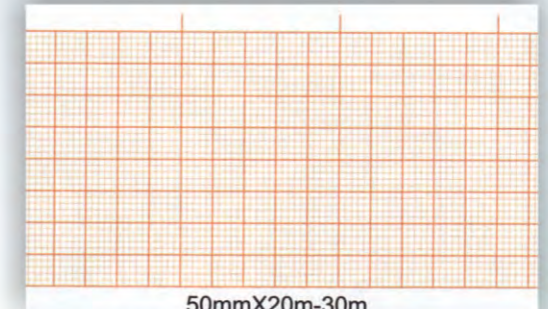

50mmX20m-30m

Single-lead ECG Paper



6-lead ECG Paper

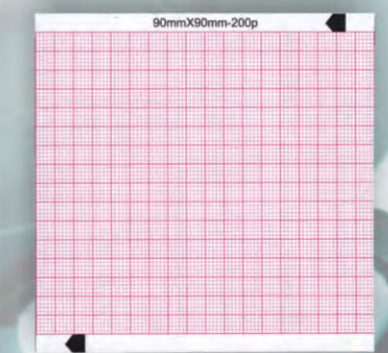

3-lead ECG Paper

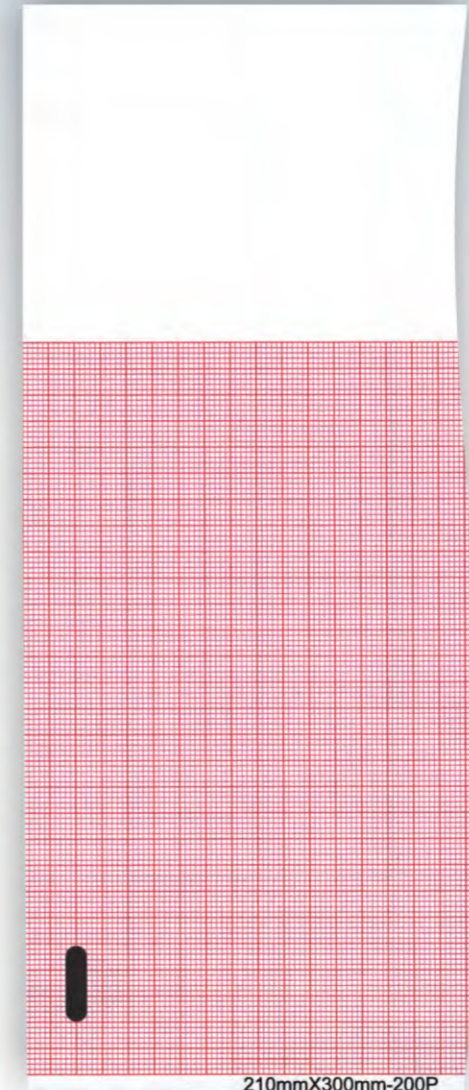

210mmX300mm-200P

12-lead ECG Paper

- Single-lead ECG Paper: 50mm X 20m, 200pcs/ctn
- 3-lead ECG Paper: 90mm X 90mm-200P, 100pcs/ctn
- 6-lead ECG Paper: 112mm X 90mm-200P, 100pcs/ctn
- 12-lead ECG Paper: 210mm X 300mm-200P, 20pcs/ctn

## GT129-100 Cervical Scraper (wooden)

1pc/paper wrap, 100pcs/box  
Non-sterile: 100pcs/box



## GT128-100 Wooden Tongue Depressor GT128-200 Plastic Tongue Depressor

Size Adult: 150mmx18mmx1.6mm  
Sterile: Single Medical Paper Wrapped,  
1pc/paper wrap, 100pcs/box  
Non-sterile: 100pcs/box  
Size Child: 140x14x1.6mm  
Sterile: Single Medical Paper Wrapped,  
1pc/paper wrap, 100pcs/box  
Non-sterile: 100pcs/box



## GT148-203 Lubricating Jelly Series

Name	Package	Amount/Unit	Units/Case
Lubricating Jelly 3g	Bag	144/bx	12/cs
Lubricating Jelly 5g	Bag	144/bx	12/cs
Lubricating Jelly 5g	Tube	144/bx	4/cs
Lubricating Jelly 42g	Tube	12/bx	6/cs
Lubricating Jelly 57g	Tube	12/bx	6/cs
Lubricating Jelly 82g	Tube	12/bx	6/cs
Lubricating Jelly 113g	Tube	12/bx	6/cs
Lubricating Jelly 1.0oz	Bag	20/bx	18/cs



## GT113-100 Condom

Surface: smooth, dotted, ribbed lubricated  
Size: 49mm, 52mm, 55cm  
Be available with spermicide nonoxynal  
Be available with various fruit smell  
If quantity is large enough, the condom is available with various color  
Specification is available with En600, ISO4074, ASTM, WHO, SABS, etc.





## Disposable Electrode

To comply with CE, ISO 13485:2003 and FDA,  
 Comfortable and Convenient, no residual and non-irritable  
 Excellent adhesive from special gel formula  
 Different sizes and material have been studied to meet the different requirements.

### General Monitoring

Foam Recommended for ICU/CCU, Surgery, Emergency			
Item Code	Description	Packaging	Case Dimension
GT148-SF 01	Child, Solid Gel, 36x44mm	50/pk, 40pk/cs	48x36x28cm
GT148-SF 05	Adult, Solid Gel, 42x50mm	50/pk, 40pk/cs	48x36x28cm
GT148-SF 08	Adult, Solid Gel, Ø50mm	50/pk, 40pk/cs	48x36x28cm
GT148-BA 08	With 4mm banana plug, Ø50mm	50/pk, 40pk/cs	43x55x28cm
GT148-SF 07	Neonatal, Solid Gel, Ø25.4mm	50/pk, 40pk/cs	40x36x28cm
Cloth Recommended for ICU/CCU, Emergency, Long term			
Item Code	Description	Packaging	Case Dimension
GT148-SN 08	Cloth, Solid Gel, Ø50mm	50/pk, 40pk/cs	40x36x28cm
Clear Tape Recommended for ICU/CCU, Surgery, Emergency, Long term, Holter			
Item Code	Description	Packaging	Case Dimension
GT148-ST 31	Breathable clear tape, Solid Gel, Ø50mm	50/pk, 40pk/cs	40x36x28cm

## Disposable Electrosurgical Pencil

- 170mm-ABS Pencil appearance
- 7cm Stainless steel tip
- 2.36mm-diameter of the tip
- 3m-PVC medical cable
- Maximal out put current:1A
- Frequency confine:0-1.0MHZ
- Ways of aseptic technique: Sterile EO
- Current resistance:200



## Radio Translucent

Foam Recommended for Surgery, Emergency, Cath Lab, Radiology			
Item Code	Description	Packaging	Case Dimension
GT148-SC 08	Adult, Solid Gel, Ø50mm	50/pk, 40pk/cs	40x36x28cm

## Stress / Diaphoretic

Recommended for ICU/CCU, Surgery, Stress, Holter, Emergency			
Item Code	Description	Packaging	Case Dimension
GT148-SF 10	Adult, Solid Gel, 42x37mm	50/pk, 40pk/cs	40x36x28cm

## Wet Gel

Recommended usage ICU/CCU, Surgery, Stress, Holter, EMS, Emergency			
Item Code	Description	Packaging	Case Dimension
GT148-WF 32	Adult, Wet Gel, 52x47mm	50/pk, 40pk/cs	40x36x28cm

## Repositionable

Recommended usage ICU/CCU, Surgery, Emergency, Cath Lab, Radiology			
Item Code	Description	Packaging	Case Dimension
GT148-RS 01	Adult, Solid Gel, 32x40mm	3/pk, 10pk/bx, 12bx/cs	48x22x22cm



### GT148-200 Medical Conductive Paste

Property Unit Value  
 Sound Speed(35°C)M/s1520-1620  
 Electric Resistance(35°C)-13-17  
 Unit Area Acoustic Impedance (35°C)  
 Pa-s/m1.5-1.7x106 Sound Attenuation  
 (35°C)Db/(cm.mhz)≤0.05  
 Viscosity (25°C)Pa.s≥15  
 Ph-5.5-8.0  
 Size: 60ml, 100ml, 150ml, 250ml



### GT148-201/202 Ultrasonic Gel

Property Unit Value  
 Sound Speed(35°C)m/s1520-1620  
 Unit area acoustic impedance (35°C)  
 Pa-s/m1.5-1.7x106 Sound attenuation  
 (35°C)dB/(cm.Mhz)≤0.05  
 Viscosity (25°C)Pa.s≥15  
 PH-5.5-5.8  
 Size: 250ml, 1000ml, 2500ml, 5000ml



### GT170-100 Self-sealing flat pouch

Size: 57x100mm	200pcs/box,	12000pcs/ctn,	27.6x37x30cm	13.5/12.5kgs
90x230mm	200pcs/box	4000pcs/ctn,	27.3x38.2x30cm	14.2/13.2kgs
135x255mm	200pcs/box	3000pcs/ctn,	29.8x40.4x30cm	17/16kgs
190x330mm	200pcs/box	2000pcs/ctn,	37.3x39.6x30cm	19.7/18.7kgs
250x370mm	200pcs/box	1000pcs/ctn,	26.3x41.3x30cm	15/14kgs



### GT170-101 Heat-sealing flat pouch

Size: 57x130mm	200pcs/box	14400pcs/ctn	27.6x37x30cm	15.8/14.8kgs
90x230mm	200pcs/box	4800pcs/ctn	38.2x23.x30cm	16/15kgs
135x255mm	200pcs/box	3600pcs/ctn	26.8x42.4x30cm	18.1/17.1kgs
190x330mm	200pcs/box	2400pcs/ctn	34.3x29.6x30cm	21.5/20.5kgs
250x370mm	200pcs/box	1200pcs/ctn	38.3x26.3x30cm	16.4/15.4kgs



### GT170-102 Heat-sealing gusseted pouch

Size: (75+25)x300mm	100pcs/box,	3000pcs/ctn,	31.3x40x30cm	12.12/11.12kgs
(100+50)x300mm	100pcs/box,	2400pcs/ctn,	31.3x42.2x30cm	12.8/11.8kgs
(150+50)x400mm	100pcs/box,	1200pcs/ctn,	41.3x31.6x30cm	12.8/11.8kgs
(200+55)x400mm	100pcs/box,	600pcs/ctn,	21.3x41.3x30cm	9.25/8.25kgs
(250+60)x450mm	100pcs/box,	600pcs/ctn,	26.3x46.3x30cm	12.15/11.15kgs



### GT170-103 Heat-sealing flat reel

Size: 55mmx200m	1roll/box	6rolls/ctn	22.5x42x23cm	10.58/9.58kgs
75mmx200m	1roll/box	5rolls/ctn	22.5x46x23cm	11.75/10.75kgs
100mmx200m	1roll/box	4rolls/ctn	22.5x47x23cm	10/9kgs
150mmx200m	1roll/box	2rolls/ctn	22.5x34x23cm	9.8/8.8kgs
400mmx200m	non-box	1roll/ctn	22x41.5x22cm	12.4/11.4kgs



### GT170-104 Heat-sealing gusseted reel

Size: (75mm+25mm)x100m	1roll/box	5rolls/ctn	22.5x46x23cm	8.75/7.75kgs
(100mm+50mm)x100m	1roll/box	4rolls/ctn	22.5x47x23cm	9.2/8.2kgs
(150mm+50mm)x100m	1roll/box	2rolls/ctn	22.5x34x23cm	7.4/6.4kgs
(400mm+75mm)x100m	non-box	1roll/ctn	22x41x22cm	9.2/8.2kgs



### GT170-105 Self-sealing connecting pouches

Size: 38x92mm	200pcs/box,	4000pcs/ctn	39x26.6x30cm	14.5/13.5kgs
50x120mm	200pcs/box	3000pcs/ctn	26x47x58cm	15.1/14.1kgs



### GT170-106 Heat-sealing connecting pouches

38x118mm	200pcs/box	4800pcs/ctn	24.6x39.6x30cm	12.98/11.98kgs
50x150mm	200pcs/box	3600pcs/ctn	26x47x30cm	16.2/15.2kgs

### GT171-100 Autoclave Indicator Tape,

#### A.Characteristics

1. Commodity: Autoclave Steam Tape,
2. Specification: Size Length And Width Are As Customer Request. Normally Size: 12.5mmx50m, 19mmx50m, 25mmx50mm Etc.
3. Backing Material: Good Quality Creped Paper
4. Color: Light Yellow
5. Adhesive: Acrylic Pressure Sensitive Adhesive
6. Characteris: 

Item	Unit	Standard
Adhesive Content	G/m2	115±5
180°C Peel	N/25mm	≥5
Time & Temperature	°Cmin	121°C±3
Color Range		Light Yellow→ Black

